

Engineering Software

GX Works2 Beginner's Manual (Simple Project)

-SW1DNC-GXW2-E

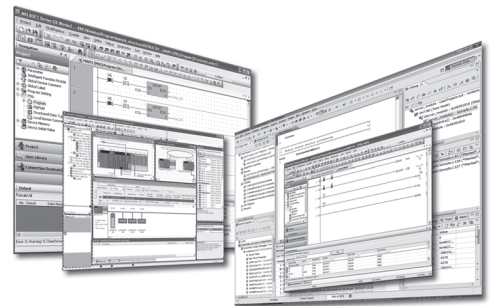

● SAFETY PRECAUTIONS ●

(Always read these instructions before using this product.)

Before using this product, thoroughly read this manual and the relevant manuals introduced in this manual and pay careful attention to safety and handle the products properly.

The precautions given in this manual are concerned with this product. For the safety precautions of the programmable controller system, refer to the User's Manual for the CPU module.

In this manual, the safety precautions are ranked as "⚠ WARNING" and "⚠ CAUTION".



Indicates that incorrect handling may cause hazardous conditions, resulting in death or severe injury.



Indicates that incorrect handling may cause hazardous conditions, resulting in minor or moderate injury or property damage.

Note that the ⚠ CAUTION level may lead to serious consequences according to the circumstances. Always follow the precautions of both levels because they are important for personal safety.

Please save this manual to make it accessible when required and always forward it to the end user.

[Design Instructions]

WARNING

- When data change, program change, or status control is performed from a personal computer to a running programmable controller, create an interlock circuit outside the programmable controller to ensure that the whole system always operates safely. Furthermore, for the online operations performed from a personal computer to a programmable controller CPU, the corrective actions against a communication error due to such as a cable connection fault should be predetermined as a system.

[Startup and Maintenance Instructions]

CAUTION

- The online operations performed from a personal computer to a running programmable controller CPU (Program change when a programmable controller CPU is RUN, operating status changes such as forced input/output operation and RUN-STOP switching, and remote control operation) must be executed after the manual has been carefully read and the safety has been ensured. When changing a program while a programmable controller CPU is RUN, it may cause a program corruption in some operating conditions. Fully understand the precautions described in GX Works2 Version 1 Operating Manual (Common) before use.
- The positioning test functions of OPR, JOG, inching or positioning data for QD75/LD75 positioning module must be executed with the programmable controller set to STOP after the manual has been carefully read and the safety has been ensured. Specially when executing the function on the network system, ensure the safety thoroughly since the machinery whose operation cannot be checked by an operator may be activated. The operation failure may cause the injury or machine damage.

● CONDITIONS OF USE FOR THE PRODUCT ●

- (1) Mitsubishi programmable controller ("the PRODUCT") shall be used in conditions;
- i) where any problem, fault or failure occurring in the PRODUCT, if any, shall not lead to any major or serious accident; and
 - ii) where the backup and fail-safe function are systematically or automatically provided outside of the PRODUCT for the case of any problem, fault or failure occurring in the PRODUCT.
- (2) The PRODUCT has been designed and manufactured for the purpose of being used in general industries.

MITSUBISHI SHALL HAVE NO RESPONSIBILITY OR LIABILITY (INCLUDING, BUT NOT LIMITED TO ANY AND ALL RESPONSIBILITY OR LIABILITY BASED ON CONTRACT, WARRANTY, TORT, PRODUCT LIABILITY) FOR ANY INJURY OR DEATH TO PERSONS OR LOSS OR DAMAGE TO PROPERTY CAUSED BY the PRODUCT THAT ARE OPERATED OR USED IN APPLICATION NOT INTENDED OR EXCLUDED BY INSTRUCTIONS, PRECAUTIONS, OR WARNING CONTAINED IN MITSUBISHI'S USER, INSTRUCTION AND/OR SAFETY MANUALS, TECHNICAL BULLETINS AND GUIDELINES FOR the PRODUCT.

("Prohibited Application")

Prohibited Applications include, but not limited to, the use of the PRODUCT in;

- Nuclear Power Plants and any other power plants operated by Power companies, and/or any other cases in which the public could be affected if any problem or fault occurs in the PRODUCT.
- Railway companies or Public service purposes, and/or any other cases in which establishment of a special quality assurance system is required by the Purchaser or End User.
- Aircraft or Aerospace, Medical applications, Train equipment, transport equipment such as Elevator and Escalator, Incineration and Fuel devices, Vehicles, Manned transportation, Equipment for Recreation and Amusement, and Safety devices, handling of Nuclear or Hazardous Materials or Chemicals, Mining and Drilling, and/or other applications where there is a significant risk of injury to the public or property.

Notwithstanding the above, restrictions Mitsubishi may in its sole discretion, authorize use of the PRODUCT in one or more of the Prohibited Applications, provided that the usage of the PRODUCT is limited only for the specific applications agreed to by Mitsubishi and provided further that no special quality assurance or fail-safe, redundant or other safety features which exceed the general specifications of the PRODUCTS are required. For details, please contact the Mitsubishi representative in your region.

REVISIONS

The manual number is written at the bottom left of the back cover.

| Print date | Manual number | Revision |
|------------|--------------------|--|
| Jul., 2008 | SH(NA)-080787ENG-A | First edition |
| Jan., 2009 | SH(NA)-080787ENG-B | <p>Model Addition Q00UJ, Q00U, Q01U, Q10UDH, Q10UDEH, Q20UDH, Q20UDEH, FXCPU</p> <p>Addition MANUALS, Section 1.1, Section 3.6, Section 4.1</p> <p>Correction GENERIC TERMS AND ABBREVIATIONS IN THIS MANUAL, Section 1, Section 2.2, Section 3.2.1, Section 3.2.2, Section 3.2.5, Section 3.2.6, Section 3.2.7, Section 3.2.8, Section 3.3.1, Section 3.3.2, Section 3.4.1, Section 3.4.2, Section 4.1.2, Section 4.2.6, Section 4.4.1</p> |
| Jul., 2009 | SH(NA)-080787ENG-C | <p>Model Addition Q00J, Q00, Q01</p> <p>Addition MANUALS, Section 1.1, Section 2.2, Section 4.2</p> <p>Correction MANUALS, Section 3.1, Section 3.2, Section 3.3, Section 3.4, Section 3.5, Section 3.6, Section 3.7, Section 3.8, Section 3.9, Section 4.1, Section 4.2, Section 4.4, Section 4.7</p> |
| Oct., 2009 | SH(NA)-080787ENG-D | <p>Correction SAFETY PRECAUTIONS, Section 1.2, Section 3.2.3, Section 3.2.5, Section 3.7.1, Section 3.7.2, Section 3.7.3, Section 3.8, Section 3.9, Section 4.2.5</p> |
| Jan., 2010 | SH(NA)-080787ENG-E | <p>Model Addition L02, L26-BT</p> <p>Addition CONDITIONS OF USE FOR THE PRODUCT</p> <p>Correction MANUALS, GENERIC TERMS AND ABBREVIATIONS IN THIS MANUAL, Section 3.2.1, Section 3.2.2, Section 3.2.3, Section 3.2.4, Section 3.2.5, Section 3.2.6, Section 3.2.8, Section 3.3.2, Section 3.4.1, Section 3.4.2, Section 3.5, Section 3.6, Section 3.7.2, Section 3.7.4, Section 4.2.6, Section 4.4.1</p> |
| Apr., 2010 | SH(NA)-080787ENG-F | <p>Correction SAFETY PRECAUTIONS, MANUALS, GENERIC TERMS AND ABBREVIATIONS IN THIS MANUAL, Section 3.2.1, Section 3.2.2, Section 3.2.3, Section 3.2.8, Section 3.3.1, Section 3.3.2, Section 3.4.1, Section 3.4.2, Section 3.5, Section 3.9, Section 4.2.6, Section 4.4.1</p> |

| Print date | Manual number | Revision |
|------------|--------------------|---|
| Sep., 2010 | SH(NA)-080787ENG-G | <p>Addition Section 4.2.7</p> <p>Correction GENERIC TERMS AND ABBREVIATIONS IN THIS MANUAL, Section 3.2.2, Section 3.2.3, Section 3.2.6, Section 3.3.1, Section 3.3.2, Section 3.5, Section 3.6, Section 4.1.2, Section 4.2.3, Section 4.2.5, Section 4.2.6, Section 4.2.8</p> |
| Jan., 2011 | SH(NA)-080787ENG-H | <p>Correction MANUALS, Section 2.1, Section 3.2.1, Section 3.2.2, Section 3.2.3, Section 3.2.4, Section 3.2.5, Section 3.2.6, Section 3.2.8, Section 3.3.1, Section 3.3.2, Section 3.4.1, Section 3.4.2, Section 3.5, Section 3.6, Section 3.7.2, Section 3.7.3, Section 3.7.4, Section 3.8, Section 4.2.6, Section 4.2.7, Section 4.4.1, Section 4.7</p> |
| Jul., 2011 | SH(NA)-080787ENG-I | <p>Correction MANUALS, Section 1.1, Section 2.2, Section 3.2.1, Section 3.2.2, Section 3.2.3, Section 3.2.6, Section 3.2.7, Section 3.2.8, Section 3.3.2, Section 3.4.1, Section 3.4.2, Section 3.6, Section 3.7.1, Section 3.7.2, Section 3.7.3, Section 3.8, Section 3.9, Section 4.1.2, Section 4.2.6, Section 4.2.7, Section 4.4.1</p> |
| Jan., 2012 | SH(NA)-080787ENG-J | <p>Correction MANUALS, GENERIC TERMS AND ABBREVIATIONS IN THIS MANUAL, Section 3.2.3, Section 3.2.6, Section 3.3.1, Section 3.4.1, Section 3.4.2, Section 3.8, Section 4.2.6, Section 4.2.7, Section 4.2.8, Section 4.4.1</p> |
| May, 2012 | SH(NA)-080787ENG-K | <p>Correction MANUALS, GENERIC TERMS AND ABBREVIATIONS IN THIS MANUAL, Section 3.2.1, Section 3.2.2, Section 3.2.3, Section 3.2.5, Section 3.2.6, Section 3.4.1, Section 3.4.2, Section 4.2.6, Section 4.2.7, Section 4.4.1</p> |
| Feb., 2013 | SH(NA)-080787ENG-L | <p>Correction GENERIC TERMS AND ABBREVIATIONS IN THIS MANUAL, Section 3.2.6, Section 3.2.8, Section 3.3.2, Section 3.4.1, Section 3.4.2, Section 3.5, Section 4.2.6, Section 4.2.7, Section 4.4.1</p> |
| May, 2013 | SH(NA)-080787ENG-M | <p>Model Addition Q04UDPV, Q06UDPV, Q13UDPV, Q26UDPV, L02S-P, L06-P, L26-P, FX3s</p> <p>Correction MANUALS, GENERIC TERMS AND ABBREVIATIONS IN THIS MANUAL, Section 3.2.1, Section 3.2.2, Section 3.2.3, Section 3.3.1</p> |
| Dec., 2013 | SH(NA)-080787ENG-N | <p>Correction Section 3.2.3, Section 3.8, Section 3.9</p> |
| Jun., 2014 | SH(NA)-080787ENG-O | Front cover correction |

| Print date | Manual number | Revision |
|------------|--------------------|--|
| Jun., 2015 | SH(NA)-080787ENG-P | <div data-bbox="580 365 715 432" style="border: 1px solid black; padding: 2px;">Correction</div> Section 3.4.2 |
| | | |

Japanese Manual Version SH-080733-R

This manual confers no industrial property rights or any rights of any other kind, nor does it confer any patent licenses. Mitsubishi Electric Corporation cannot be held responsible for any problems involving industrial property rights which may occur as a result of using the contents noted in this manual.

INTRODUCTION

Thank you for purchasing the Mitsubishi integrated FA software, MELSOFT series.
Before using the product, thoroughly read this manual to develop full familiarity with the functions and performance to ensure correct use.

CONTENTS

| | |
|---|--------|
| SAFETY PRECAUTIONS | A - 1 |
| CONDITIONS OF USE FOR THE PRODUCT | A - 2 |
| REVISIONS | A - 3 |
| INTRODUCTION | A - 6 |
| CONTENTS | A - 6 |
| MANUALS | A - 8 |
| GENERIC TERMS AND ABBREVIATIONS IN THIS MANUAL..... | A - 16 |

1 OVERVIEW 1 - 1 to 1 - 6

| | |
|---|-------|
| 1.1 Simple Project and Structured Project | 1 - 2 |
| 1.2 Program Creation Procedure | 1 - 4 |

2 CREATED PROGRAM AND SYSTEM CONFIGURATION 2 - 1 to 2 - 2

| | |
|----------------------------------|-------|
| 2.1 System Configuration | 2 - 2 |
| 2.2 Overview of Program Creation | 2 - 2 |

3 CREATING A PROGRAM OF LADDER 3 - 1 to 3 - 46

| | |
|---|--------|
| 3.1 Created Program | 3 - 2 |
| 3.1.1 Operations of program | 3 - 2 |
| 3.1.2 Created program | 3 - 2 |
| 3.2 Creating a Project | 3 - 3 |
| 3.2.1 Starting GX Works2 | 3 - 3 |
| 3.2.2 Screen configuration in GX Works2 | 3 - 4 |
| 3.2.3 Creating a new project | 3 - 5 |
| 3.2.4 Setting parameters | 3 - 7 |
| 3.2.5 Setting labels..... | 3 - 8 |
| 3.2.6 Creating a program | 3 - 11 |
| 3.2.7 Converting ladder blocks..... | 3 - 16 |
| 3.2.8 Compiling a program..... | 3 - 17 |
| 3.3 Writing a Project to the programmable controller | 3 - 19 |
| 3.3.1 Connecting the personal computer to the programmable controller | 3 - 19 |
| 3.3.2 Writing a project to the programmable controller | 3 - 24 |
| 3.4 Monitoring Operations | 3 - 27 |
| 3.4.1 Monitoring a program | 3 - 27 |
| 3.4.2 Batch monitoring of device values | 3 - 32 |

| | | |
|-------|--|--------|
| 3.5 | Diagnosing the programmable controller | 3 - 36 |
| 3.6 | Reading a Project from programmable controller | 3 - 37 |
| 3.7 | Printing | 3 - 39 |
| 3.7.1 | Setting the printer | 3 - 39 |
| 3.7.2 | Previewing a program..... | 3 - 40 |
| 3.7.3 | Printing a program | 3 - 42 |
| 3.7.4 | Previewing a PLC Parameter | 3 - 43 |
| 3.7.5 | Printing a PLC Parameter..... | 3 - 44 |
| 3.8 | Saving a Project | 3 - 45 |
| 3.9 | Exiting GX Works2 | 3 - 46 |

4 CREATING A PROGRAM OF SFC

4 - 1 to 4 - 31

| | | |
|-------|---|--------|
| 4.1 | Created Program | 4 - 2 |
| 4.1.1 | Operations of program..... | 4 - 2 |
| 4.1.2 | Created Program | 4 - 3 |
| 4.2 | Created Program | 4 - 4 |
| 4.2.1 | Starting GX Works2..... | 4 - 4 |
| 4.2.2 | Screen configuration in GX Works2 | 4 - 4 |
| 4.2.3 | Creating a new project..... | 4 - 4 |
| 4.2.4 | Setting parameters | 4 - 4 |
| 4.2.5 | Setting labels (for QCPU/LCPU) | 4 - 5 |
| 4.2.6 | Creating a program (for QCPU/LCPU)..... | 4 - 6 |
| 4.2.7 | Creating a program (for FXCPU)..... | 4 - 15 |
| 4.2.8 | Compiling a program (for QCPU/LCPU) or converting an SFC diagram (for FXCPU)..... | 4 - 26 |
| 4.3 | Writing a Project to the programmable controller | 4 - 27 |
| 4.4 | Monitoring Operations | 4 - 27 |
| 4.4.1 | Monitoring a program | 4 - 27 |
| 4.4.2 | Batch monitoring of device values..... | 4 - 29 |
| 4.5 | Diagnosing the programmable controller | 4 - 30 |
| 4.6 | Reading a Project from programmable controller | 4 - 30 |
| 4.7 | Printing | 4 - 30 |
| 4.8 | Saving a Project | 4 - 30 |
| 4.9 | Exiting GX Works2 | 4 - 30 |

■ MANUALS

Related manuals are separately issued according to the purpose of their functions for GX Works2.

● Related manuals

The manuals related to this product are shown below.

Refer to the following tables when ordering required manuals.

1) Operation of GX Works2

| Manual name | Manual number (Manual code) |
|--|--------------------------------|
| GX Works2 Version 1 Operating Manual (Common) Explains the system configuration of GX Works2 and the functions common to a Simple project and Structured project such as parameter setting and the operating method for the online function. (Sold separately) | SH-080779ENG (13JU63) |
| GX Works2 Version 1 Operating Manual (Simple Project) Explains operation methods such as creating and monitoring programs in Simple project of GX Works2. (Sold separately) | SH-080780ENG (13JU64) |
| GX Works2 Version 1 Operating Manual (Simple Project, Function Block) Explains methods for such as creating function blocks, pasting function blocks to sequence programs, and operating FB library in Simple project of GX Works2. (Sold separately) | SH-080984ENG (13JU72) |
| GX Works2 Version 1 Operating Manual (Structured Project) Explains operation methods such as creating and monitoring programs in Structured project of GX Works2. (Sold separately) | SH-080781ENG (13JU65) |
| GX Works2 Version 1 Operating Manual (Intelligent Function Module) Explains operation methods of intelligent function module such as parameter setting, monitoring programs, and predefined protocol support function in GX Works2. (Sold separately) | SH-080921ENG (13JU69) |
| GX Works2 Beginner's Manual (Structured Project) Explains fundamental operation methods such as creating, editing and monitoring programs in Structured project for users inexperienced with GX Works2. (Sold separately) | SH-080788ENG (13JZ23) |

2) Structured Programming

| Manual name | Manual number (Manual code) |
|--|--------------------------------|
| MELSEC-Q/L/F Structured Programming Manual (Fundamentals) Explains the programming methods, types of programming languages, and other information required to create structured programs. (Sold separately) | SH-080782ENG (13JW06) |
| MELSEC-Q/L Structured Programming Manual (Common Instructions) Explains the specifications and functions of common instructions such as sequence instructions, basic instructions, and application instructions, that can be used in structured programs. (Sold separately) | SH-080783ENG (13JW07) |
| MELSEC-Q/L Structured Programming Manual (Application Functions) Explains the specifications and functions of application functions that can be used in structured programs. (Sold separately) | SH-080784ENG (13JW08) |
| MELSEC-Q/L Structured Programming Manual (Special Instructions) Explains the specifications and functions of special instructions such as module dedicated instruction, PID control instruction, and built-in I/O function dedicated instruction, that can be used in structured programs. (Sold separately) | SH-080785ENG (13JW09) |
| FXCPU Structured Programming Manual [Device & Common] Explains the devices and parameters provided in GX Works2 for structured programming. (Sold separately) | JY997D26001 (09R925) |
| FXCPU Structured Programming Manual [Basic & Applied Instruction] Explains the sequence instructions provided in GX Works2 for structured programming. (Sold separately) | JY997D34701 (09R926) |
| FXCPU Structured Programming Manual [Application Functions] Explains the application functions provided in GX Works2 for structured programming. (Sold separately) | JY997D34801 (09R927) |

3) Operation of iQ Works

| Manual name | Manual number (Manual code) |
|---|--------------------------------|
| Let's start iQ Works Version 2 Explains fundamental operation methods such as managing the system using MELSOFT Navigator and using system labels for users inexperienced with GX Works2. (Sold separately) | SH-081261ENG (13JZ79) |

Point

The Operating Manuals are included on the CD-ROM of the software package in a PDF file format. Manuals in printed form are sold separately for single purchase. Order a manual by quoting the manual number (model code) listed in the table above.



● Purpose of this manual

This manual explains the operation for creating sequence programs in Simple project, one of the functions supported with GX Works2.











Manuals for reference are listed in the following table according to their purpose.

For information such as the contents and manual number of each manual, refer to the list of 'Related manuals'.

1) Installation of GX Works2 and USB driver















| Purpose | GX Works2 Installation Instructions | GX Works2 Version 1 Operating Manual |
|--|---|---|
| | | Common |
| Learning the operating environment and installation method |  | |
| Learning a USB driver installation method | |  |

2) Operation of GX Works2

| Purpose | GX Works2 Beginner's Manual | | GX Works2 Version 1 Operating Manual | | | | |
|--|---|---|---|---|---|---|---|
| | Simple Project | Structured Project | Common | Simple Project | | Structured Project | Intelligent Function Module |
| | | | | | Function Block | | |
| Learning all functions of GX Works2 | | |  | | | | |
| Learning the project types and available languages in GX Works2 | | |  | | | | |
| Learning the basic operations and operating procedures when creating a simple project for the first time |  | | | | | | |
| Learning the basic operations and operating procedures when creating a structured project for the first time | |  | | | | | |
| Learning the operations of available functions regardless of project type. | | |  | | | | |
| Learning the functions and operation methods for programming | | |  |  | |  | |
| Learning the operations and operating procedures when creating function blocks (FB) in Simple project. | | | | |  | | |
| Learning data setting methods for intelligent function module | | | | | | |  |















3) Operations in each programming language

For details of instructions used in each programming language, refer to the section 4 / section 5 on the next page.











| Purpose | | GX Works2 Installation Instructions | GX Works2 Beginner's Manual | | GX Works2 Version 1 Operating Manual | | | |
|-----------------------|-----------------------|---|---|---|---|---|---|-----------------------------------|
| | | | Simple Project | Structured Project | Common | Simple Project | Structured Project | Intelligent Function Module |
| Simple Project | Ladder | |  | | |  | | |
| | SFC | | *1  | | |  | | |
| | ST | | |  | | |  | |
| Structured Project | Ladder | |  | | |  | | |
| | SFC | | *1  | | |  | | |
| | Structured Ladder/FBD | | |  | | |  | |
| | ST | | |  | | |  | |

*1: MELSAP3 and FX series SFC only

4) Details of instructions in each programming language (for QCPU (Q mode)/LCPU)

| Purpose | | MELSEC-Q/L/F Structured Programming Manual | MELSEC-Q/L Structured Programming Manual | | | MELSEC-Q/L Programming Manual | MELSEC-Q/L/QnA Programming Manual | | Manual for module to be used |
|--|--|---|---|---|---|--|---|---|---|
| | | Fundamentals | Common Instructions | Special Instructions | Application Functions | Common Instructions | PID Control Instructions | SFC | - |
| All languages | Learning details of programmable controller CPU error codes, special relays, and special registers | | | | |  | | | |
| Using ladder language | Learning the types and details of common instructions | | | | |  | | | |
| | Learning the types and details of instructions for intelligent function modules | | | | | | | |  |
| | Learning the types and details of instructions for network modules | | | | | | | |  |
| | Learning the types and details of instructions for the PID control function | | | | | |  | | |
| Using SFC language | Learning details of specifications, functions, and instructions of SFC (MELSAP3) | | | | | | |  | |
| Using Structured Ladder/FBD or ST language | Learning the fundamentals for creating a structured program |  | | | | | | | |
| | Learning the types and details of common instructions | |  | | | | | | |
| | Learning the types and details of instructions for intelligent function modules | | |  | | | | |  |
| | Learning the types and details of instructions for network modules | | |  | | | | |  |
| | Learning the types and details of instructions for the PID control function | | |  | | |  | | |
| | Learning the types and details of application functions | | | |  | | | | |

5) Details of instructions in each programming language (for FXCPU)

| Purpose | | MELSEC-Q/L/F Structured Programming Manual | FXCPU Structured Programming Manual | | | FXCPU Programming Manual | | |
|--|--|---|---|---|---|---|---|---|
| | | Fundamentals | Device & Common | Basic & Applied Instruction | Application Functions | FX0, FX0S, FX0N, FX1, FXu, FX2C | FX1S, FX1N, FX2N, FX1NC, FX2NC | FX3S, FX3G, FX3U, FX3GC, FX3UC |
| Using ladder language | Learning the types and details of basic/application instructions, descriptions of devices and parameters | | | | |  |  |  |
| Using SFC language | Learning details of specifications, functions, and instructions of SFC | | | | |  |  |  |
| Using Structured Ladder/FBD or ST language | Learning the fundamentals for creating a structured program |  | | | | | | |
| | Learning the descriptions of devices, parameters, and error codes | |  | | | | | |
| | Learning the types and details of sequence instructions | | |  | | | | |
| | Learning the types and details of application instructions | | | |  | | | |

● How to read this manual

Chapter heading

Index on the right of the page number clarifies the chapter of currently opened page.

Section title

Clarifies the section of currently opened page.

Reference location

leads to the reference location and reference manuals.

Section title

Clarifies the section of currently opened page.

3.2 Creating a Project

3.2.4 Setting parameters

Set parameters.

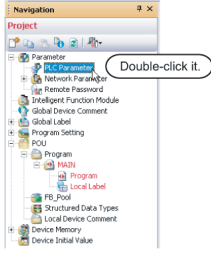

1. Double-click "Parameter" → "PLC Parameter" on the Project view to display the Q Parameter Setting screen.

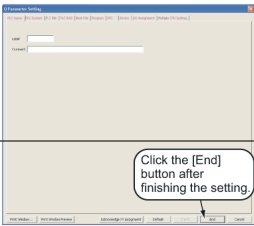

2. Click the button to determine the settings and close the screen. The parameters remain unchanged from the initial setting in the example in this manual. Refer to the following manuals for the details on parameter setting:

- GX Works2 Version 1 Operating Manual (Common)
- Manual of the programmable controller being used
- Manual of the Network being used

3.2.4 Setting parameters 3 - 7

* Since the above page was created for explanation purpose, it differs from the actual page.

This manual also uses the following columns:



This explains notes for requiring attention or useful functions relating to the information given on the same page.

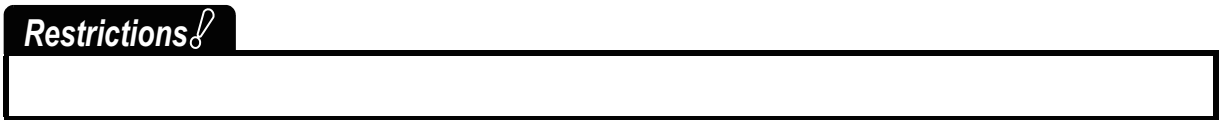

This explains restrictions relating to the information given on the same page.

● Symbols used in this manual

The following shows the symbols used in this manual with descriptions and examples.

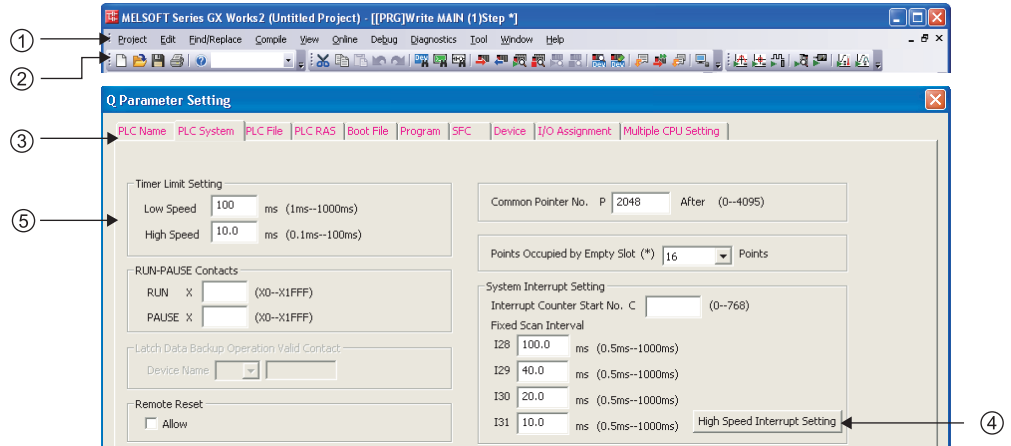

| No. | Symbol | Description | Example |
|-----|--------|-------------------------|-------------------------------------|
| (1) | [] | Menu name on a menu bar | [Project] |
| (2) | | Toolbar icon | |
| (3) | << >> | Tab name in a screen | <<PLC System>> |
| (4) | | Button on a screen | High Speed Interrupt Setting button |
| (5) | " " | Item name in a screen | "Timer Limit Setting" |
| - | | Keyboard key | Ctrl |

■ GENERIC TERMS AND ABBREVIATIONS IN THIS MANUAL

This manual uses the generic terms and abbreviations listed in the following table to discuss the software packages and programmable controller CPUs. Corresponding module model names are also listed if needed.

| Generic terms and Abbreviations | Description |
|---------------------------------|--|
| GX Works2 | Generic product name for SWnDNC-GXW2-E model (n: version) |
| Existing application | - |
| GX Developer | Generic product name for SWnD5C-GPPW-E, SWnD5C-GPPW-EA, SWnD5C-GPPW-EV, and SWnD5C-GPPW-EVA (n: version) |
| GX Simulator | Generic product name for SWnD5C-GPPW-E, SWnD5C-GPPW-EA, SWnD5C-GPPW-EV, and SWnD5C-GPPW-EVA (n: version) |
| iQ Works | Abbreviation for MELSOFT iQ Works |
| Personal computer | Generic term for personal computers on which Windows® operates |
| Q series | Abbreviation for Mitsubishi programmable controller MELSEC-Q series |
| L series | Abbreviation for Mitsubishi programmable controller MELSEC-L series |
| FX series | Abbreviation for Mitsubishi programmable controller MELSEC-F series |
| Basic model QCPU | Generic term for Q00J, Q00, Q01 |
| High Performance model QCPU | Generic term for Q02, Q02H, Q06H, Q12H, and Q25H |
| Universal model QCPU | Generic term for Q00UJ, Q00U, Q01U, Q02U, Q03UD, Q03UDE, Q03UDV, Q04UDH, Q04UDEH, Q04UDV, Q04UDPV, Q06UDH, Q06UDEH, Q06UDV, Q06UDPV, Q10UDH, Q10UDEH, Q13UDH, Q13UDEH, Q13UDV, Q13UDPV, Q20UDH, Q20UDEH, Q26UDH, Q26UDEH, Q26UDV, Q26UDPV, Q50UDEH, and Q100UDEH |
| QCPU (Q mode) | Generic term for Basic model QCPU, High Performance model QCPU, Process CPU, Redundant CPU, and Universal model QCPU |
| LCPU | Generic term for L02S, L02S-P, L02, L02-P, L06, L06-P, L26, L26-P, L26-BT, and L26-PBT |
| FXCPU | Generic term for FX0s, FX0, FX0N, FX1s, FX1N, FX1NC, FXU, FX2c, FX2N, FX2NC, FX3s, FX3G, FX3GC, FX3U, and FX3UC |
| CPU module | Generic term for QCPU (Q mode), LCPU, and FXCPU |
| SFC | Generic term for MELSAP3, MELSAP-L, and FX series SFC |



1 OVERVIEW

This manual explains the procedures to actually create a program (Simple Project) using GX Works2 and operate the programmable controller using the created program.

If this is your first time creating a Simple Project using GX Works2, you are recommended to read this manual first, and then use GX Works2.

Refer to the following manual for Structured Projects:

 GX Works2 Beginner's Manual (Structured Project)

| | |
|--|------------|
| 1.1 Simple Project and Structured Project | 1-2 |
| 1.2 Program Creation Procedure | 1-4 |

| | |
|---|--|
| 1 | OVERVIEW |
| 2 | CREATED PROGRAM AND SYSTEM CONFIGURATION |
| 3 | CREATING A PROGRAM OF LADDER |
| 4 | CREATING A PROGRAM OF SFC |

1.1 Simple Project and Structured Project

■ Simple Project

In a Simple Project, you can create sequence programs using instructions for the Mitsubishi programmable controller CPU.

The Simple Project offers the same operability for program creation as the conventional GX Developer.

You can create sequence programs using the following programming languages:

● Graphic languages

• Ladder

Use this graphic language to describe programs as ladders consisting of contacts, coils, etc., using the same operating procedures as the conventional GX Developer.

• SFC

Use this graphic language to describe sequence control in a way easy to understand.

Describe steps which specify the processing and transition conditions which specify conditions for proceeding to the next step.

You can describe steps and transition conditions using the ladder language.

● Text language

• ST (Structured Text)

This text language allows you to describe controls by syntax including alternative sequences offered by conditional sentences and repetition offered by repetition sentences in the same way as high-level languages such as the C language. Accordingly, you can briefly create programs easy to look at.

■ Structured Project

In a Structured Project, you can create programs by structured program.

By dividing controls into small portions and making parts of common contents, you can create programs easy to understand and applicable to many cases (by structured program.)

You can create sequence programs using the following programming languages:

● Graphic languages

• Ladder

Use this graphic language to describe programs as ladders consisting of contacts, coils, etc., using the same operating procedures as the conventional GX Developer.

• Structured Ladder/FBD

Structured Ladder is created based on the relay circuit design technology. Because this language is easy to understand intuitively, it is used generally for sequence programs.

Every ladder always starts from a base line on the left.

Structured Ladder consists of contacts, coils, function blocks and functions which are connected each other with vertical lines and horizontal lines.

FBD connects functions and function blocks with ruled lines to describe ladders.

• SFC

Use this graphic language to describe sequence control in a way easy to understand.

Describe steps which specify the processing and transition conditions which specify conditions for proceeding to the next step.

You can describe steps and transition conditions using the ladder language.

- Text language

- ST (Structured Text)

- This text language allows you to describe controls by syntax including alternative sequences offered by conditional sentences and repetition offered by repetition sentences in the same way as high-level languages such as the C language. Accordingly, you can briefly create programs easy to look at.

Restrictions!

The FXCPU does not support the ST language in Simple Project, and does not support the ladder language and SFC language in Structured Project.

1.2 Program Creation Procedure

The figure below shows how to create a program with a Simple Project and execute it in a programmable controller CPU.

1. Opening a project

| Procedure | Reference |
|--|-----------|
| Start GX Works2. | 3.2.1 |
| Create a new Simple Project. Or open an existing Simple Project. | 3.2.3 |



2. Setting parameters

| Procedure | Reference |
|---------------------|-----------|
| Set the parameters. | 3.2.4 |



3. Setting labels

| Procedure | Reference |
|-----------------------|-----------|
| Define global labels. | 3.2.5 |
| Define local labels. | -- |



4. Editing the program

| Procedure | Reference |
|--|-----------|
| Edit the program in each program part. | 3.2.6 |
| | 4.2.6 |
| | 4.2.7 |



5. Conversion and compiling

| Procedure | Reference |
|------------------------|-----------|
| Convert ladder blocks. | 3.2.7 |
| Compile the program. | 3.2.8 |



(To the next page)



6. Connecting the programmable controller CPU

| Procedure | Reference |
|---|-----------|
| Connect the personal computer to the programmable controller CPU. | 3.3.1 |
| Set the connection destination. | |



7. Writing to the programmable controller

| Procedure | Reference |
|--|-----------|
| Write the parameters to the programmable controller CPU. | 3.3.2 |
| Write the program to the programmable controller CPU. | |



8. Checking operations

| Procedure | Reference |
|--|------------|
| Monitor the sequence program execution status and device contents, and check operations. | 3.4 4.4 |
| Check for errors in the programmable controller. | 3.5 |



9. Printing

| Procedure | Reference |
|-----------------------------------|------------|
| Print the program and parameters. | 3.7 4.7 |



10. Exiting GX Works2

| Procedure | Reference |
|--------------------|-----------|
| Save the project. | 3.8 |
| Exiting GX Works2. | 3.9 |



2 CREATED PROGRAM AND SYSTEM CONFIGURATION

This chapter explains the system configuration and gives an overview of the program created by using this manual.

| | |
|--|-----|
| 2.1 System Configuration | 2-2 |
| 2.2 Overview of Program Creation | 2-2 |

| | |
|---|--|
| 1 | OVERVIEW |
| 2 | CREATED PROGRAM AND SYSTEM CONFIGURATION |
| 3 | CREATING A PROGRAM OF LADDER |
| 4 | CREATING A PROGRAM OF SFC |

2.1 System Configuration

This manual uses GX Works2 and the Q Series programmable controller for explanation.

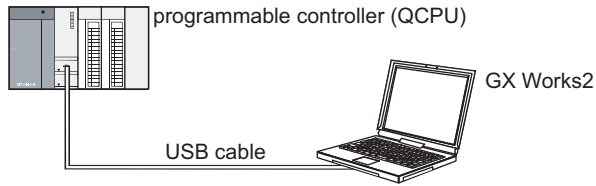

2.2 Overview of Program Creation

This manual explains the following program creation procedures using the simple example program shown in the table below.

- Creating a new project
- Setting parameters
- Setting labels
- Creating a program (inputting contacts and application instructions, converting ladder blocks and compiling the program)
- Writing to the programmable controller
- Monitoring ladder, etc.
- Preview, Printing

Table 2.1 Overview of created program

| Program language | Operation overview | Reference |
|------------------|--|-----------|
| Ladder | <p>You can create the Inline ST Box that displays ST language programs in the Ladder Editor, and edit and monitor ST language programs. Refer to the following manual for the details.</p> <p> GX Works2 Version 1 Operating Manual (Simple Project)</p> | Chapter 3 |
| SFC | | Chapter 4 |
| ST | <p>Refer to the following manual for the details.</p> <p> GX Works2 Beginner's Manual (Structured Project)</p> | |



3 CREATING A PROGRAM OF LADDER

This chapter explains how to create a program of Ladder with a Simple Project through a simple program example.

| | | |
|-----|--|------|
| 3.1 | Created Program | 3-2 |
| 3.2 | Creating a Project | 3-3 |
| 3.3 | Writing a Project to the programmable controller | 3-19 |
| 3.4 | Monitoring Operations | 3-27 |
| 3.5 | Diagnosing the programmable controller | 3-36 |
| 3.6 | Reading a Project from programmable controller | 3-37 |
| 3.7 | Printing | 3-39 |
| 3.8 | Saving a Project | 3-45 |
| 3.9 | Exiting GX Works2 | 3-46 |

3.1 Created Program

This section explains the operations of the program to be created and ladder programs.

3.1.1 Operations of program

- When X0 turns ON, the programmable controller turns ON Y10, and then turns OFF Y10 1 second later.
- When X1 turns ON, the programmable controller transfers K10 to D0 (which is defined with the Label "VAR1").
- When X2 turns ON, the programmable controller transfers K20 to D0 (which is defined with the Label "VAR1").

3.1.2 Created program

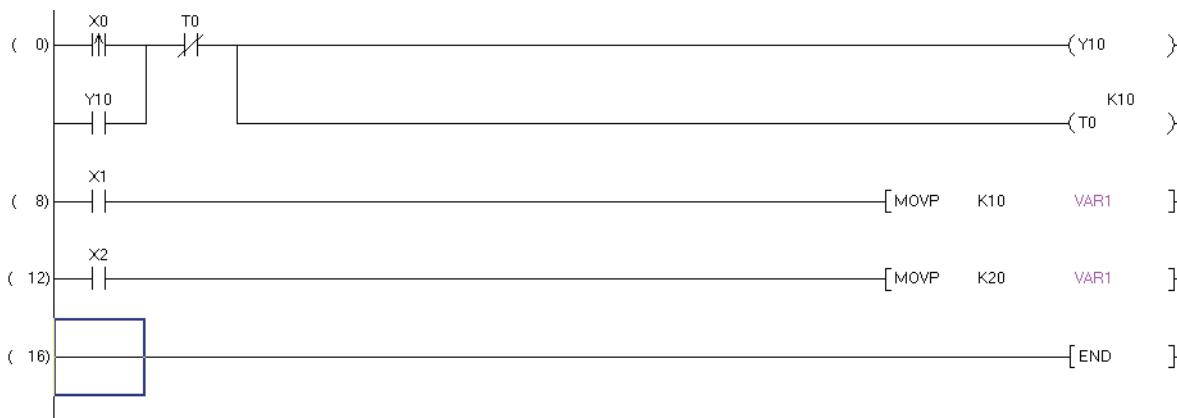

3.2 Creating a Project

Create a project using ladder programs.

3.2.1 Starting GX Works2

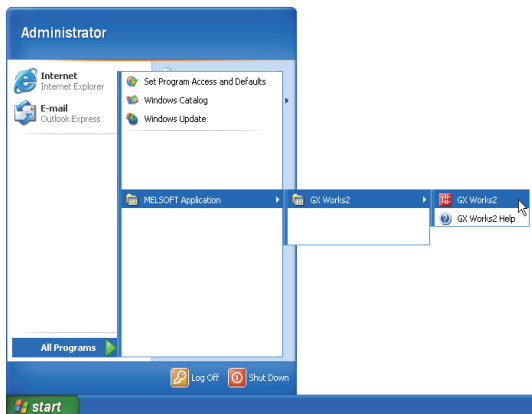

1. Select the software package menu to be started.

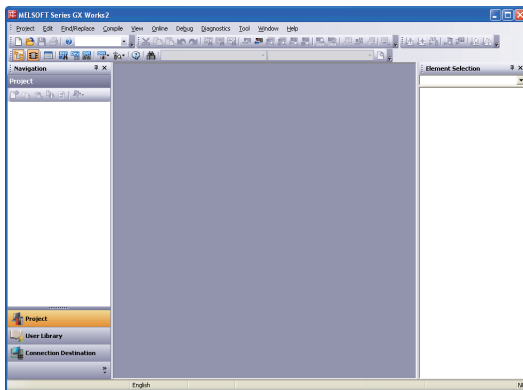

2. The selected software package is started.

Point

You can double-click the  icon on the desktop to start the software package.

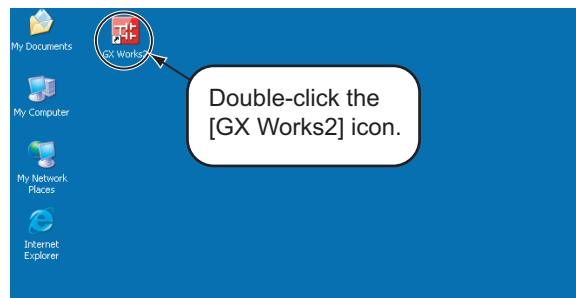

3.2.2 Screen configuration in GX Works2

The GX Works2 screen has the following configuration.

Select "View" or "Hide" in the [View] menu for each of the Toolbar, Status bar, Navigation Window, Function Block Selection window and Output window.

Refer to the following manual for the details on the GX Works2 screen configuration:

 GX Works2 Version 1 Operating Manual (Common)

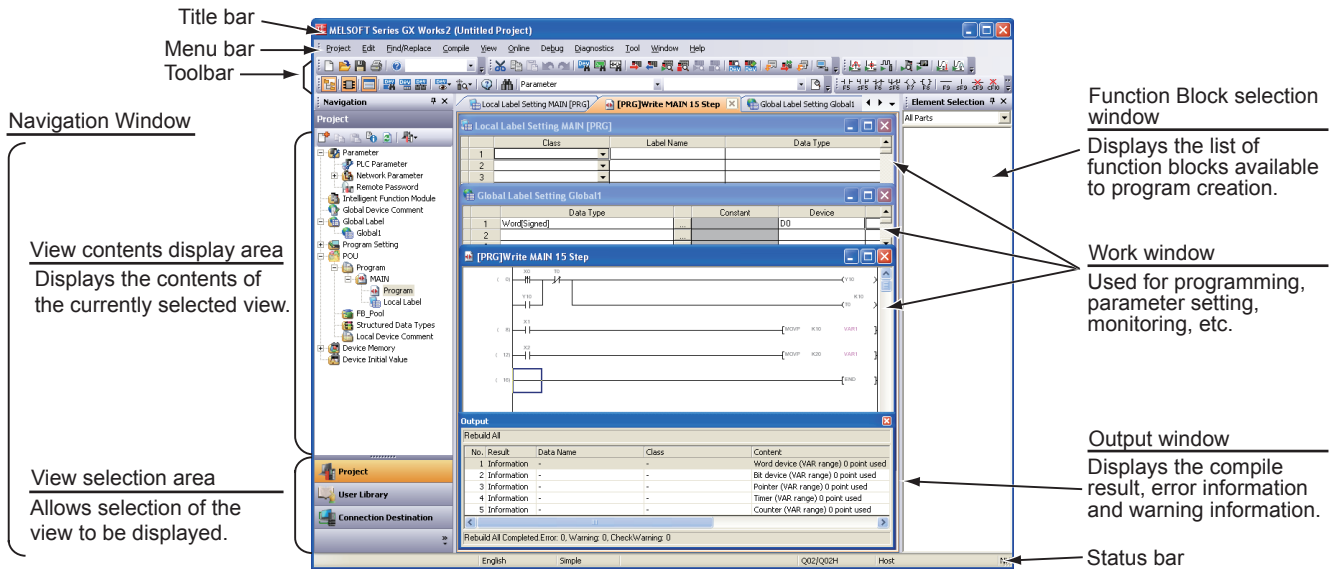

3.2.3 Creating a new project

At first, create a project.

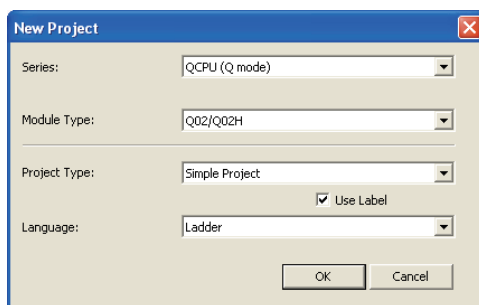
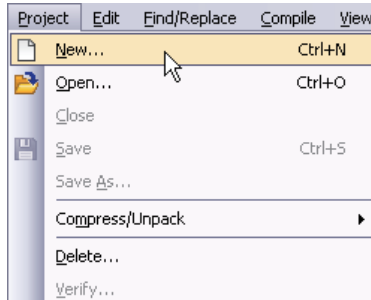

1. Perform either procedure below to display the New Project screen.

- Select [Project] → [New].
- Click  (New).

2. Select the "Series", "Module Type", "Project Type" and "Language" from the list boxes for the new project to be created.

Check "Use Label" when using labels in the program to be created.

After the setting, click the  button.

Settings

- Series : QCPU (Q mode)
- Module Type : Q02/Q02H
- Project Type : Simple Project
- Language : Ladder

Point

When using labels in Simple project, check "Use Label" on the New Project screen.

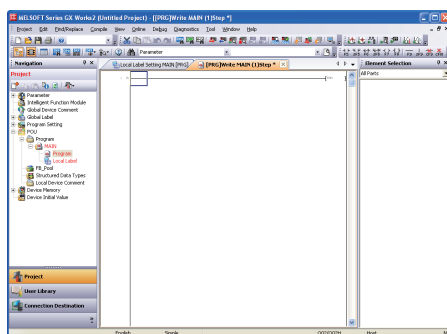

3. GX Works2 creates a new project.

Point**Opening an existing project**

The Opening an existing project function has the single file format and workspace format screens. Refer to the following manual for the details on the existing project opening procedure:

 GX Works2 Version 1 Operating Manual (Common)

1. Perform either operation below.
 - Select [Project] → [Open].
 - Click  (Open).
2. The Open Project screen appears.

Enter the folder where the project is saved.

Specify the existing project to be opened. The selected project is displayed in "File name".

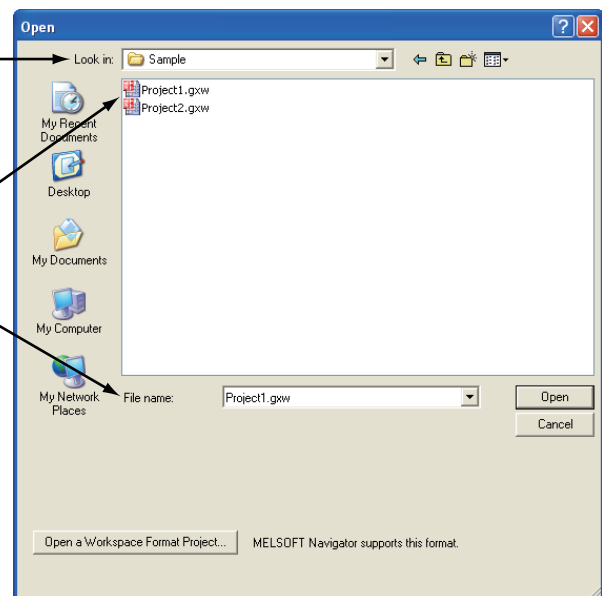

3. Click the  button to open the selected project.

3.2.4 Setting parameters

Set parameters.

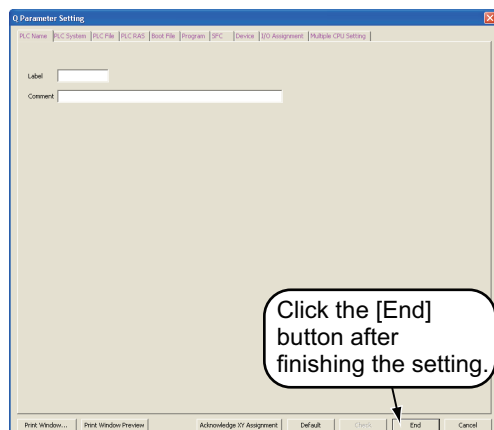
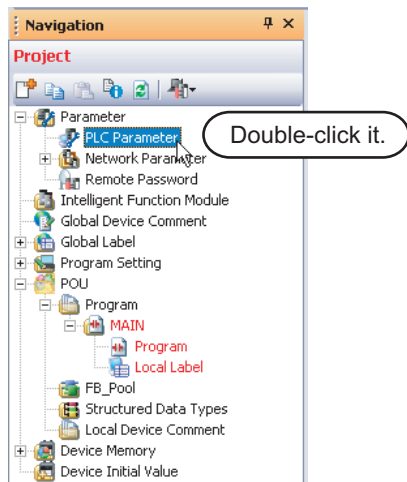



1. Double-click "Parameter" → "PLC Parameter" on the Project view to display the Q Parameter Setting screen.

2. Click the button to determine the settings and close the screen.

The parameters remain unchanged from the initial setting in the example in this manual.

Refer to the following manuals for the details on parameter setting:

-  GX Works2 Version 1 Operating Manual (Common)
-  Manual of the programmable controller being used
-  Manual of the Network being used

3.2.5 Setting labels

Set global labels.

When not using labels, proceed to Section 3.2.6.

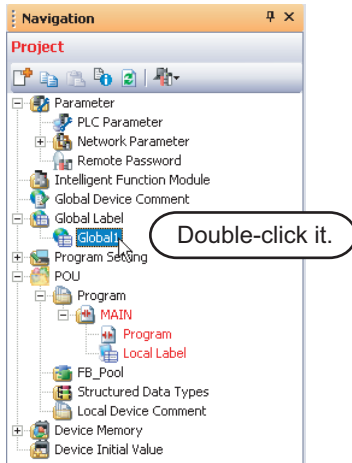

1. Double-click "Global Label" → "Global1" on the Project view to display the Global Label Setting screen.

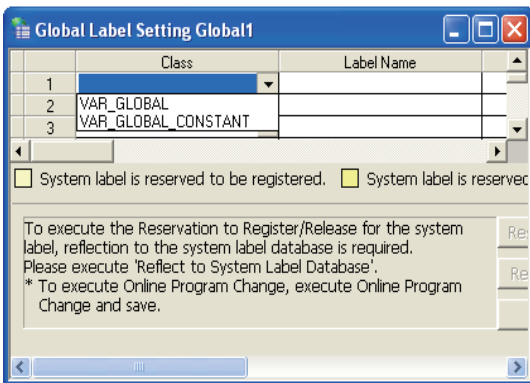

2. Select the "Class" from the list box on the Global Label Setting screen.

Settings

- Class: VAR_GLOBAL

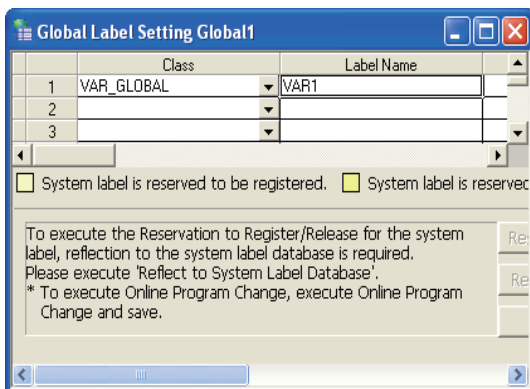

3. Directly input the "Label Name" on the Global Label Setting screen.

Settings

- Label Name: VAR1

(To the next page)

Restrictions!

- **Characters available for the label name**

You can enter up to 32 characters as the label name.

However, note that the following label name will cause a compile error.

- Label name which contains space
- Label name whose first character is a number
- Label name equivalent to a device name

For other characters unavailable for the label name, refer to the following manual.

 GX Works2 Version 1 Operating Manual (Common)

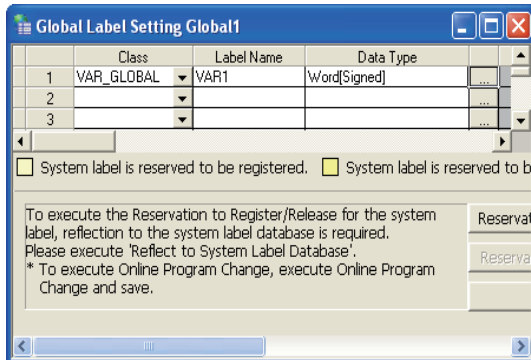

4. Directly input the "Date Type" on the Global Label Setting screen.

Settings

- Date Type: Word [Signed]

Point!

You can click  to display the Type Selection screen, and then select the Types on this screen.

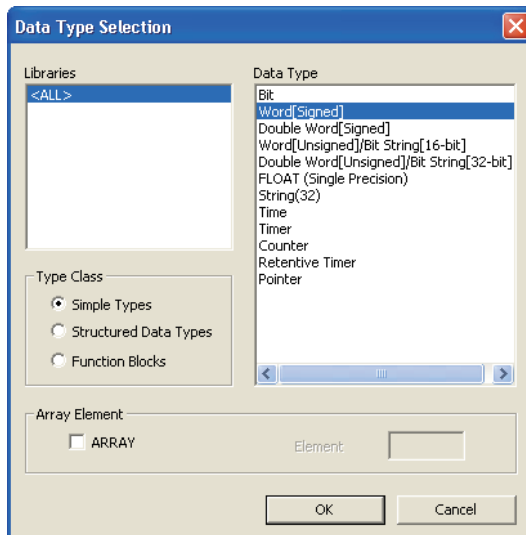

Settings*1

- 1) Libraries : ALL
- 2) Type Class : Simple Types
- 3) Types : Word [Signed]
- 4) Array Element : Not checked

*1: Set "Libraries", "Type Class", "Types" and "Array Element" in this order.

After completing the setting, click the  button.

(To the next page)

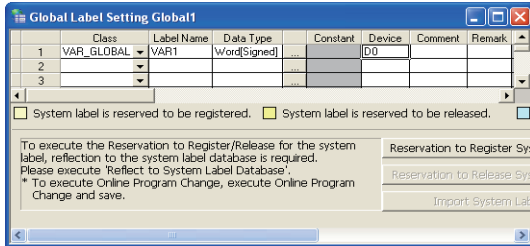
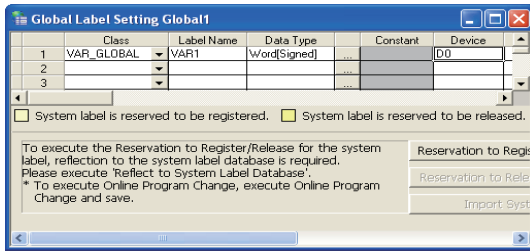

5. Directly input the "Device" on the Global Label Setting screen.

Settings

- Device: D0

6. Set the "Constant", "Comment" and "Remark" on the Global Label Setting screen.

"Relation with System Label", "System Label Name" and "Attribute" are not used in examples shown in this manual.

Settings

- Constant : When the label class is "VAR_GLOBAL", you cannot set or change the constant value.
- Comment : No setting
- Remark : No setting

Refer to the following manual for the details on the global label/local label setting procedure:

☞ GX Works2 Version 1 Operating Manual (Simple Project)

Refer to the following manual for the details on programming global labels and local labels:

☞ MELSEC-Q/L/F Structured Programming Manual (Fundamentals)

3.2.6 Creating a program

Create the ladder program shown in Section 3.1.2.

You can select the following modes when creating a program.

- "Overwrite" mode or "Insert" mode
This section explains the creation procedure in the "Overwrite" mode.
Every time you click the  key, the mode is switched between "Overwrite" and "Insert".
Select either mode as needed.
- "Write" mode or "Read" mode
Select the "Write" mode when editing the ladders.
For selecting the "Write" mode, select [Edit] → [Ladder Edit Mode] → [Write Mode] from the menu bar.

Or click  (Write Mode).

Refer to the following manual for details of the "Overwrite" mode, "Insert" mode, "Write" mode and "Read" mode.

 GX Works2 Version 1 Operating Manual (Simple Project)

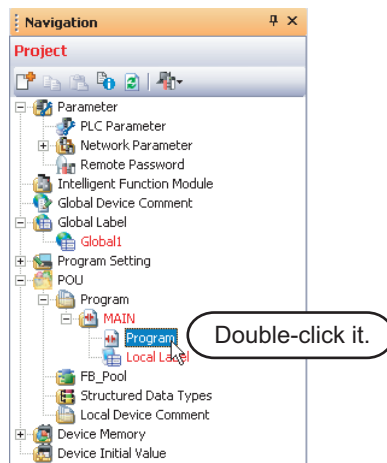

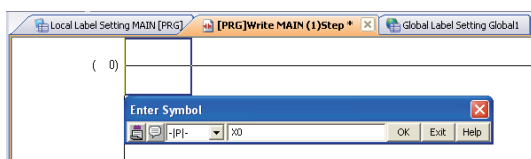

Double-click it.



(To the next page)

1. Double-click "POU" → "Program" → "MAIN" → "Program" on the Project view to display the [PRG] MAIN screen.

2. Click  (Rising Pulse) on the Ladder toolbar to display the Enter Symbol screen.
Directly input a device on the Enter Symbol screen, and click the  button to display the Rising Pulse.

Settings

- X0

Point

Click an icon on the Ladder toolbar to open the Enter Symbol screen for inputting a device or instruction. Set a device or instruction, and click the button to display the corresponding ladder symbol or vertical line in the cursor position. Ladder toolbar



Refer to the following manual for the details on the toolbar:

GX Works2 Version 1 Operating Manual (Simple Project)

Table 3.1 Icons on the Ladder toolbar mainly used in this section

| Names | Contents |
|-------------------------|-----------------------------------|
| Open Contact | Set a device. |
| Close Contact | Set a device. |
| Rising Pulse | Set a device. |
| Open Branch | Set a device. |
| Coil | Set a device. |
| Application Instruction | Input an application instruction. |
| Vertical Line | Set the number of vertical lines. |

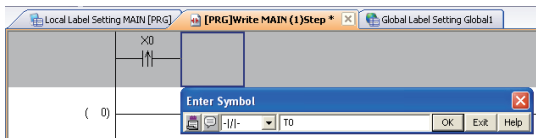

- Click (Close Contact) on the Ladder toolbar to display the Enter Symbol screen. Directly input a device on the Enter Symbol screen, and click the button to display the Close Contact.

Settings

- T0



(To the next page)

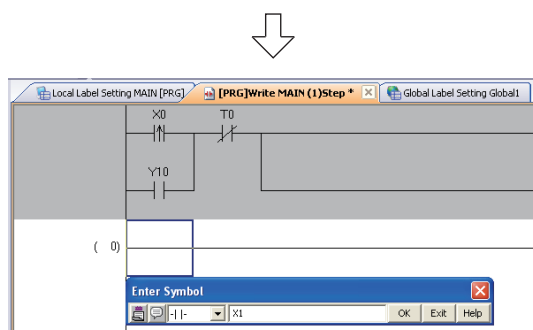
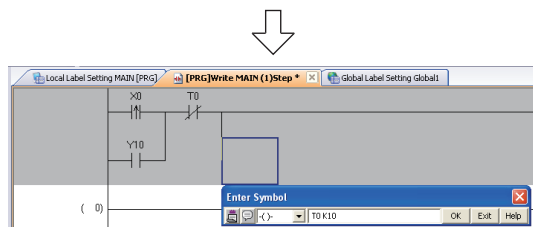
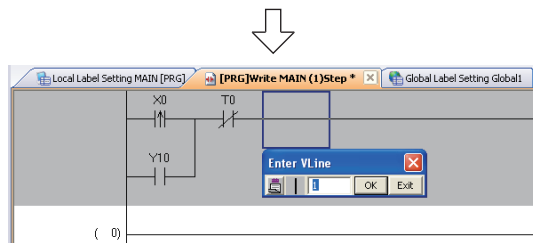
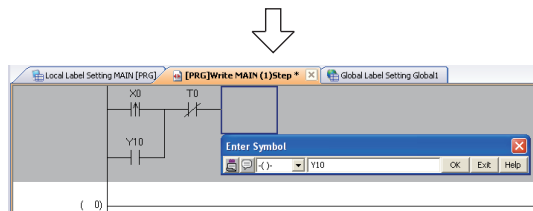
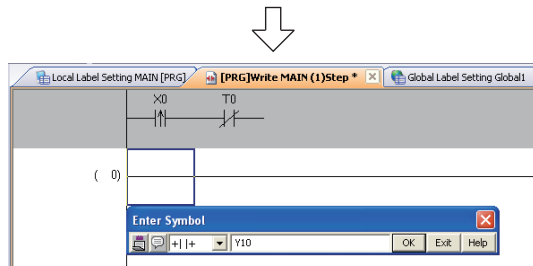

(To the next page)

4. Click  (Open Branch) on the Ladder tool bar to display the Enter Symbol screen.

Directly input a device on the Enter Symbol screen, and click the button to display the Open Branch.

Settings

- Y10

5. Click  (Coil) on the Ladder toolbar to display the Enter Symbol screen.

Directly input a device on the Enter Symbol screen, and click the button to display the Coil.

Settings

- Y10

6. Click  (Vertical Line) on the Ladder toolbar to display the Enter Vertical Line screen.

Click the button to display the Vertical Line.

7. Click  (Coil) on the Ladder toolbar to display the Enter Symbol screen.

Directly input a device and set value on the Enter Symbol screen, and click the button to display the Coil.

Settings

- T0 K10

8. Click  (Open Contact) on the Ladder tool bar to display the Enter Symbol screen.

Directly input a device on the Enter Symbol screen, and click the button to display the Open Contact.

Settings

- X1

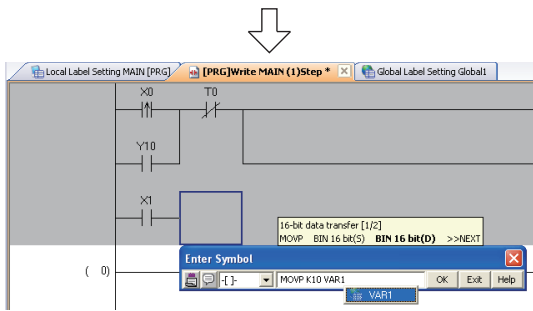



9. Click  (Application Instruction) on the Ladder toolbar to display the Enter Symbol screen.

Directly input an application instruction and operand on the Enter Symbol screen, and click the button to display the Application Instruction.

Settings

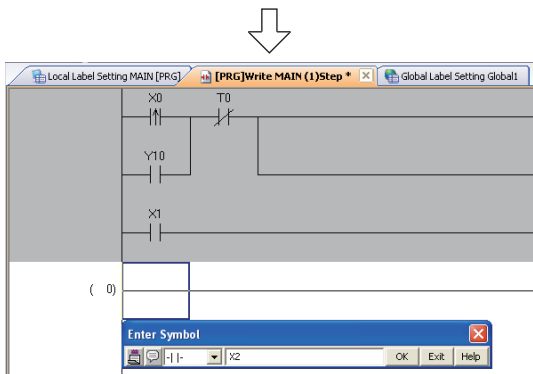
- MOV P K10 VAR1 *1
- *1: The label VAR1 is set in Section 3.2.5.
Specify the device D0 when not using labels.





10. Click  (Open Contact) on the Ladder toolbar to display the Enter Symbol screen.

Directly input a device on the Enter Symbol screen, and click the button to display the Open Contact.

Settings

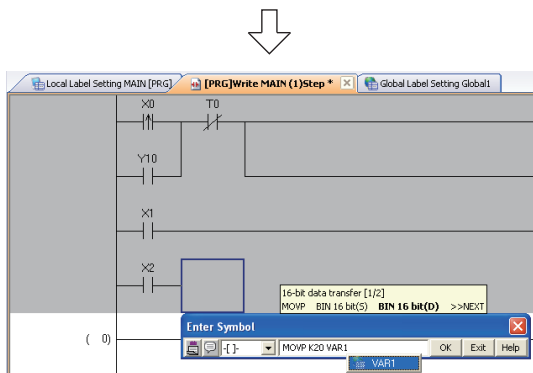
- X2



11. Click  (Application Instruction) on the Ladder toolbar to display the Enter Symbol screen.

Directly input an application instruction and operand on the Enter Symbol screen, and click the button to display the Application Instruction.

Settings

- MOV P K20 VAR1 *2
- *2: The label VAR1 is set in Section 3.2.5.
Specify the device D0 when not using labels.

| | |
|---|--|
| 1 | OVERVIEW |
| 2 | CREATED PROGRAM AND SYSTEM CONFIGURATION |
| 3 | CREATING A PROGRAM OF LADDER |
| 4 | CREATING A PROGRAM OF SFC |

Point!

- Make sure to ladder conversion and compile the created or edited program to make it a sequence program executable in the programmable controller CPU.
Only ladder conversion is required, and compilation is not required when using the FXCPU or not using labels. Refer to the following sections for ladder conversion and compile.

☞ 3.2.7 Converting ladder blocks

☞ 3.2.8 Compiling a program

- If the following operation is performed after compilation, devices are displayed instead of labels. Select [View] → [Device Display] → [Device Display] to check the menu item.
(Note that the menu item is unchecked when you select [View] → [Device Display] → [Device Display] while the menu item is checked.)

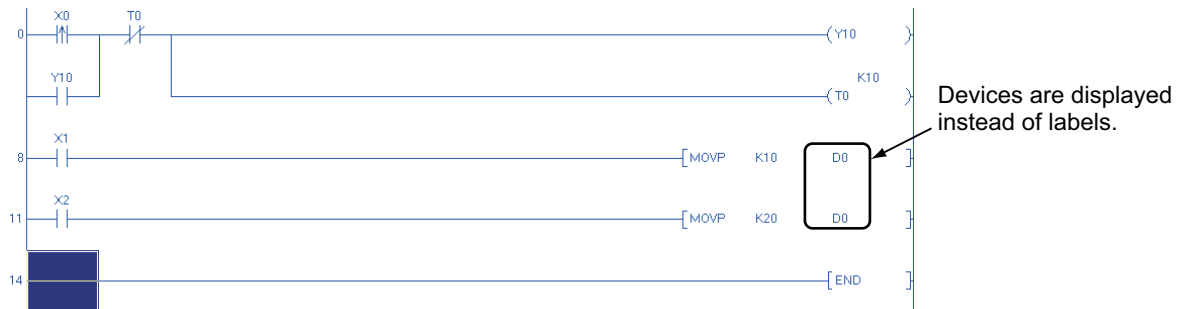

- Displaying labels and devices at the same time
Devices can be displayed at the same time in the label display mode by adding the corresponding option. Select [Tool] → [Options] to display the Options screen. Select "Program Editor" → "Ladder" → "Ladder Diagram" on the Options screen, and check "Display labels and devices".
In the example below, X1 and D0 are displayed as labels.
<Label display>



<Label/device simultaneous display>



- Displaying label candidates
GX Works2 displays label candidates whose former portion agrees with the entered character string. In this program example, GX Works2 displays labels starting from "V" when you enter "V". You can select a displayed label instead of entering the label completely.

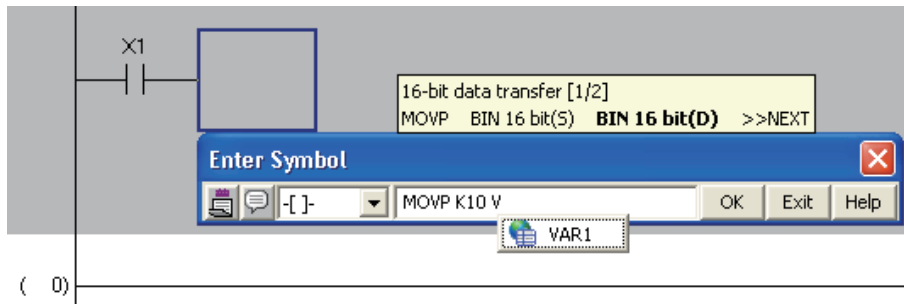

3.2.7 Converting ladder blocks

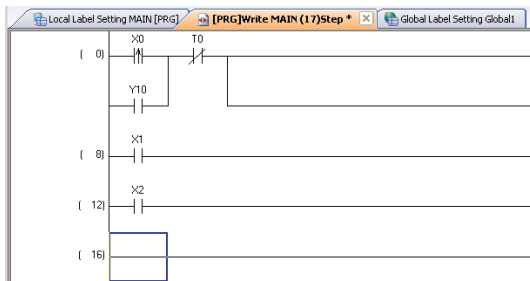
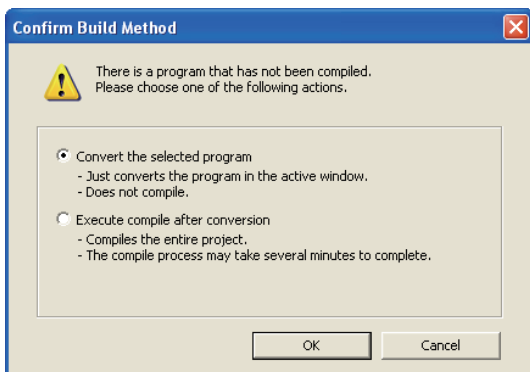
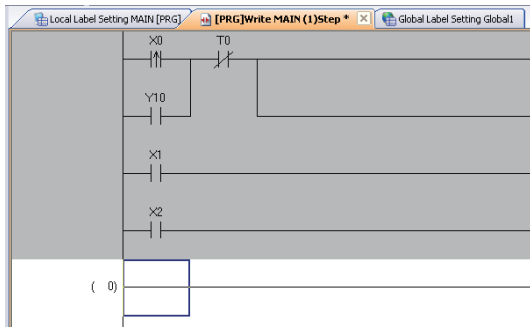

1. Select [Compile] → [Build] to display the Execution Confirmation for Build screen.
You can press the **F4** key instead to display the Execution Confirmation for Build screen.

2. Set the execution method of build.
In this example, GX Works2 will convert the selected program.

After setting the execution method, click the **OK** button to execute conversion.

Settings

- Select "Convert the selected program".

3. [Build] converts the unconverted ladder block, and changes its background color as shown on the left.

3.2.8 Compiling a program

There are following two types of compiling. The compiling target is different between the two types. Select "Rebuild All" for this example.

The "Rebuild All" procedure is described below.

Refer to the following manual for compiling:

 GX Works2 Version 1 Operating Manual (Simple Project)

Table 3.2 Compiling type and target program

| | Target program to be compiled |
|-------------|--|
| Build | Converts non-compiled programs into sequence program. (Does not compile already compiled programs.) |
| Rebuild All | Converts all programs into sequence program. (Compiles already compiled programs also.) |

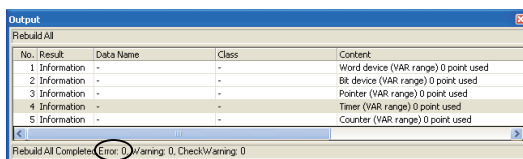
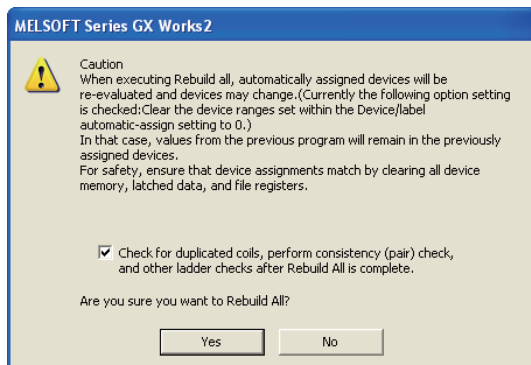
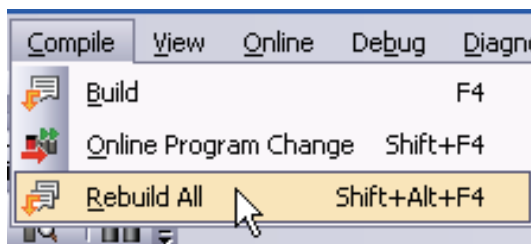

When an error is not detected.

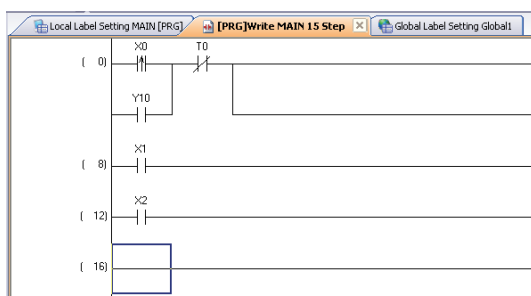

1. Select [Compile] → [Rebuild All] to execute "Rebuild All".

You can click  (Rebuild All) to execute "Rebuild All".

2. The screen shown on the left appears.

Click the button to execute "Rebuild All".

3. When finishing "Rebuild All", GX Works2 displays the result on the Output window.

If an error occurs, check the contents, eliminate the cause of error, and then execute "Build" or "Rebuild All" as described in the step 1.

4. When "Rebuild All" is completed, the number of program steps is displayed at the window title on the [PRG] Write MAIN screen.

Point

- When you convert a ladder block, GX Works2 automatically compiles the program at the time of conversion if labels are not used.
If labels are used, make sure to compile the created or edited sequence program after conversion so that the created or edited sequence program will be an executable sequence program.

Refer to the following manual for the details on "Build", "Rebuild All":

☞ GX Works2 Version 1 Operating Manual (Simple Project)

- **Compile status checking method**
You can check the compile status on the Project view.

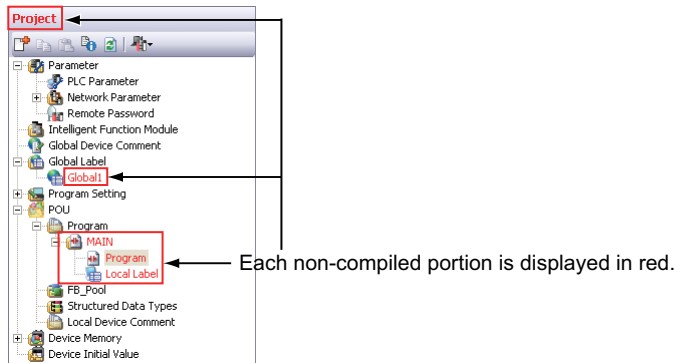

3.3 Writing a Project to the programmable controller

Write a project to the programmable controller CPU.

3.3.1 Connecting the personal computer to the programmable controller

Connect the personal computer and the programmable controller with a cable, and set the connection channel.

■ Connecting the personal computer to the programmable controller

For cautions on connection, refer to the manual of the programmable controller CPU. Refer to the following manual for the details on setting when using another channel or using the FXCPU for connection.

Notebook personal computer



USB cable

programmable controller (Q02HCPU)



■ Setting the Transfer Setup

Set the channel to connect the personal computer to the programmable controller CPU (Q02HCPU) with a USB cable.

Refer to the following manual for the details on setting using another channel:

GX Works2 Version 1 Operating Manual (Common)

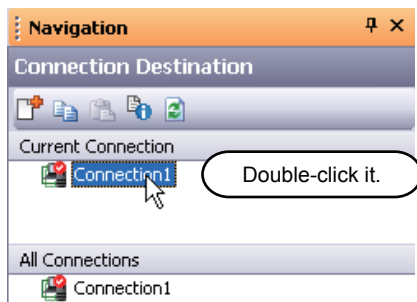

(To the next page)

1. Click "Connection Destination" in the view selection area on the Navigation window to display the Connection Destination view.
2. Double-click "Connection1" in the Current Connection on the Connection Destination view to display the Transfer Setup screen.

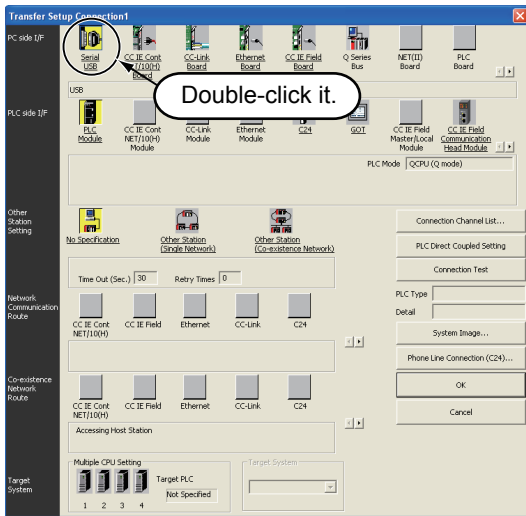

3. Double-click  (Serial USB) in "PC side I/F" to display the PC side I/F Serial setting screen.

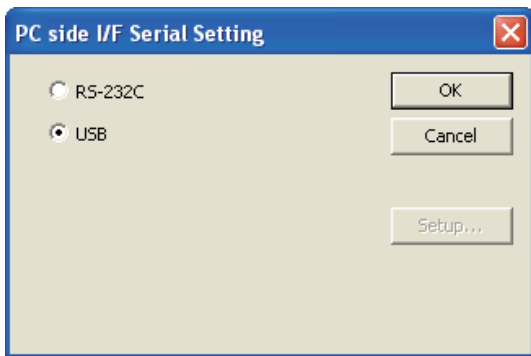



4. Set the PC side I/F.

After the setting, click the button to complete the setting and close the screen.

Settings

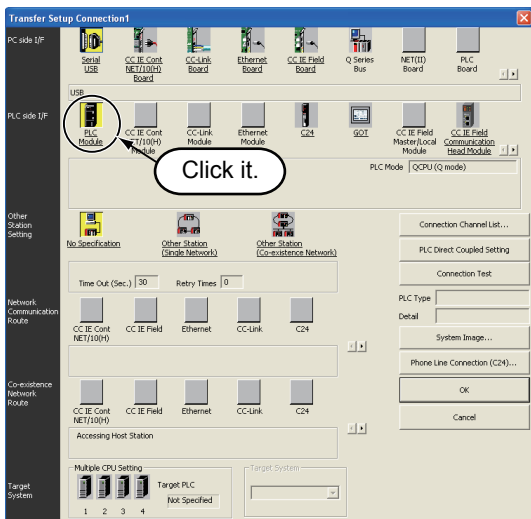
- Select "USB".



5. Click  (PLC Module) in "PLC side I/F" to select the interface to be used.



(To the next page)

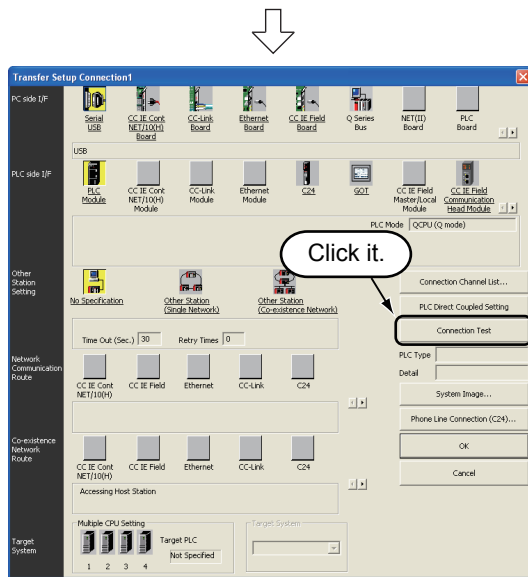

6. Click the button to execute a communication test with the programmable controller through the specified connection channel.

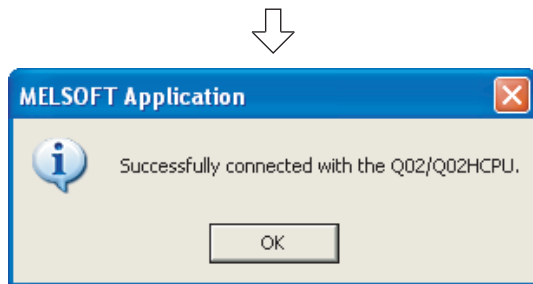

7. When communication with the programmable controller is finished normally, the left screen appears, and the "PLC Type" field displays the programmable controller CPU model name.

Click the button to close the screen.

If communication with the programmable controller has failed, the screen below appears.

Check the connection destination, connection cable, etc.

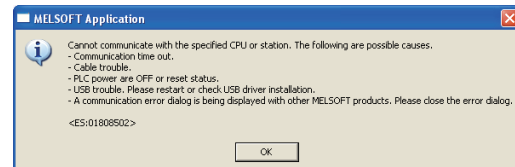

8. Click the button to finish "Transfer Setup" and close the screen.

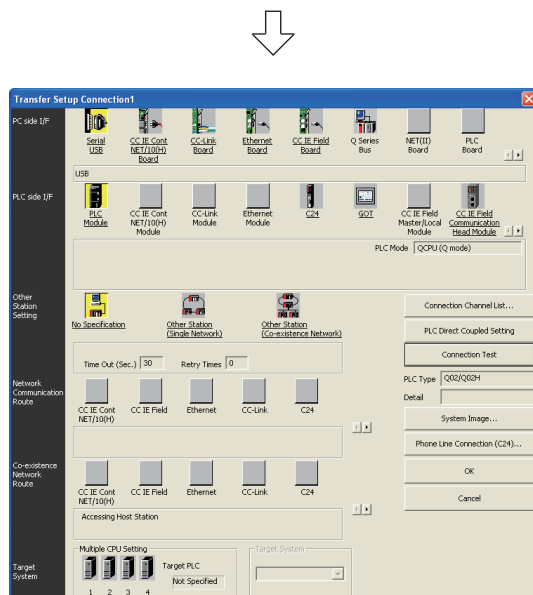

Point

- You can set two or more connection destinations and change them over if there are two or more connection destinations.

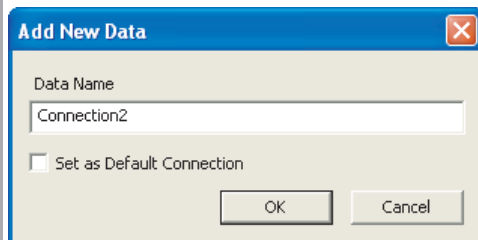
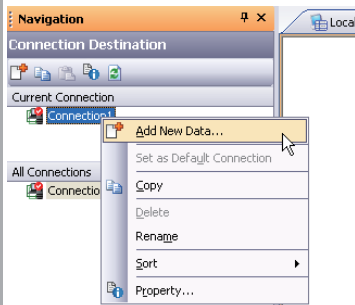

Newly created connection destination

1. Select "Connection1" in the Current Connection on the Connection Destination view, right-click it, and then select the menu item "Add New Data". The Add New Data screen will appear.
2. Set "Data Name", and uncheck "Set as Default Connection".
Click the button to display the newly created connection destination in "All Connections" on the Connection Destination view.

Settings

- Data Name : Connection2
- Set as Default Connection: Unchecked

3. Set the connection destination.
Double-click "Connection2" in "All Connections" to display the Transfer Setup screen.

 3.3.1 Step3 in the Setting the Transfer Setup

- For selecting the newly created connection destination, check "Set as Default Connection " while creating the data, or set the newly created connection destination as the default connection destination as described below. Then, the newly created connection destination will be selected as the connection destination for communication with the programmable controller CPU (for "Read from PLC", "Write to PLC", etc).

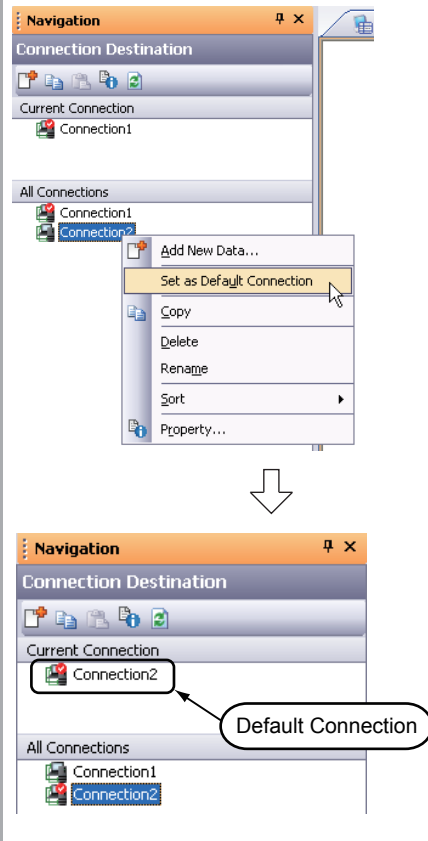

1. Select "Connection2" in the All Connections on the Connection Destination view, right-click it, and then select the menu item "Set as Default Connection".

2. The connection destination set as the default connection destination is displayed in "Current Connection" on the Connection Destination view.

3.3.2 Writing a project to the programmable controller

Write the project data to the programmable controller CPU set as the connection destination in Section 3.3.1.

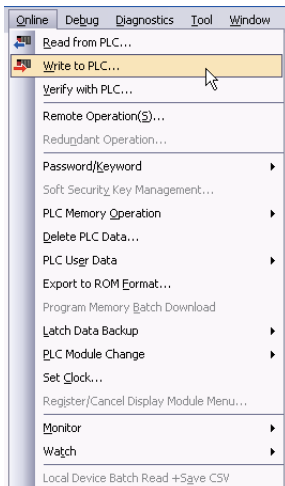

1. Select "Online" → "Write to PLC" to display the Online Data Operation screen.

You can click  (Write to PLC) to display the Online Data Operation screen.

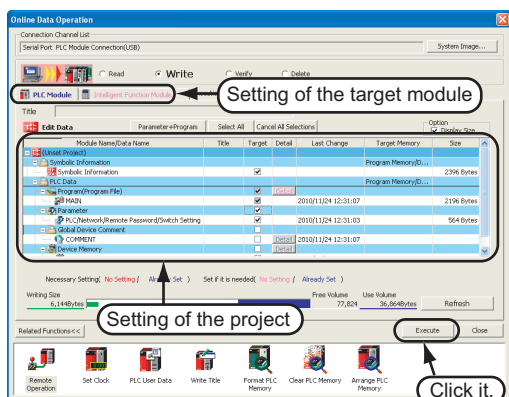

2. Set the "Target module" and "Target project" on the Online Data Operation screen.

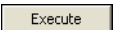
After the setting, click the  button.

Setting of the target module

- Target module: Select <<PLC Module>>

Setting of the project

- Symbolic Information : Select "Program Memory/Device Memory" in "Target Memory", and check "Symbolic Information" in "Target". "Program (Program File)" and "MAIN" are checked in "PLC Data", and change into gray. "Symbolic Information" contains program files and variables.
- PLC Data : Select "Program Memory/Device Memory" in "Target Memory", and check "PLC/Network/Remote Password/Switch Setting" in "Target". Do not check "Global Device Comment" or "Device Memory".



(To the next page)

Restrictions!

In the case of FXCPU

- The symbolic information is displayed only in the FX3U and FX3UC Series version 3.00 or later.
 - In the case of Simple project (with labels), data can be read from the FXCPU only in the FX3U and FX3UC Series version 3.00 or later.
- When data cannot be read from the FXCPU, carefully store projects written in the programmable controller.

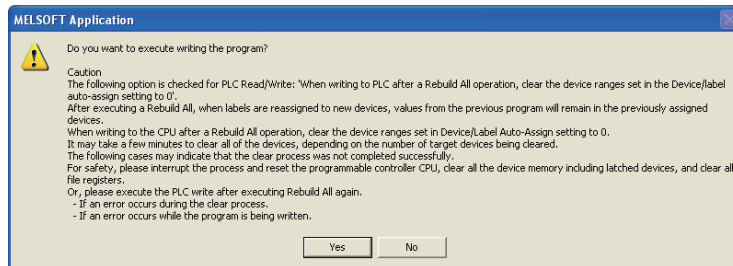

3. The left screen is displayed.

Click the button to write the project (program).

Point!

If a program or parameters already exist in the programmable controller, the following screen appears.

Click the or button to overwrite the existing program or parameters.

When you click the button, GX Works2 overwrite the existing program or parameters without displaying the overwrites confirmation screen for other data.

When parameters already exist

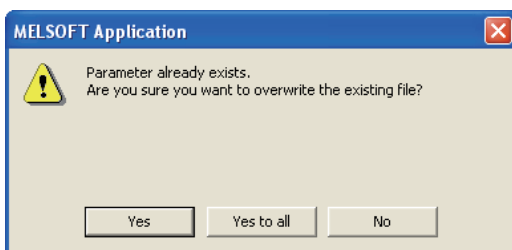

When a program already exists

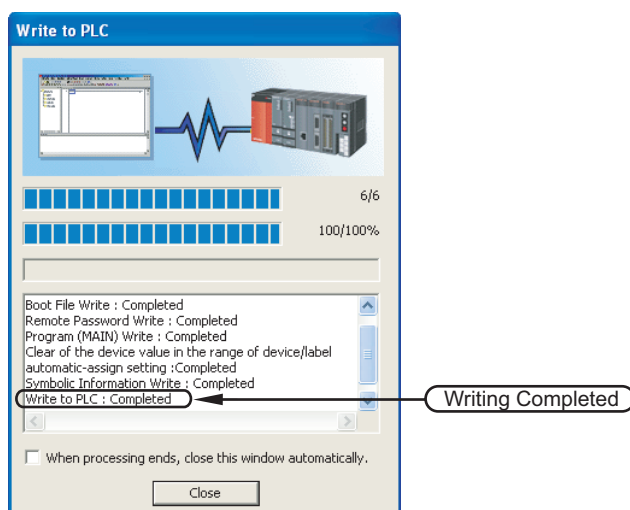
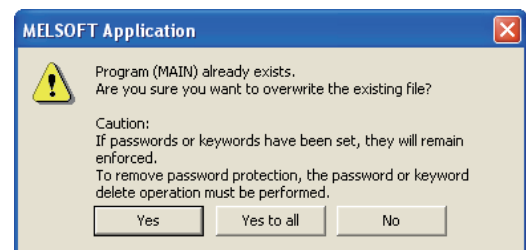

4. The left screen is displayed during writing.

When writing is finished, "Write to PLC: Completed" appears.

Click the button to close the Write to PLC screen.



(To the next page)

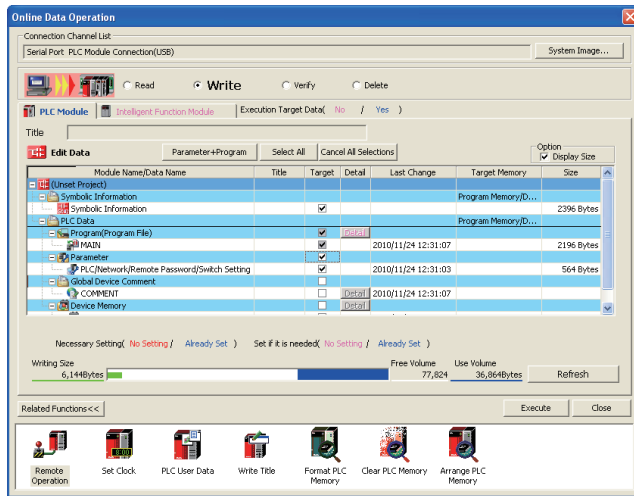

5. Click the  button to close the Online Data Operation screen.

3.4 Monitoring Operations

Execute "Monitor" to check the operations.

GX Works2 is able to simulate the programmable controller operations in offline mode.

Refer to the following manual for the simulation function:

 GX Works2 Version 1 Operating Manual (Common)

3.4.1 Monitoring a program

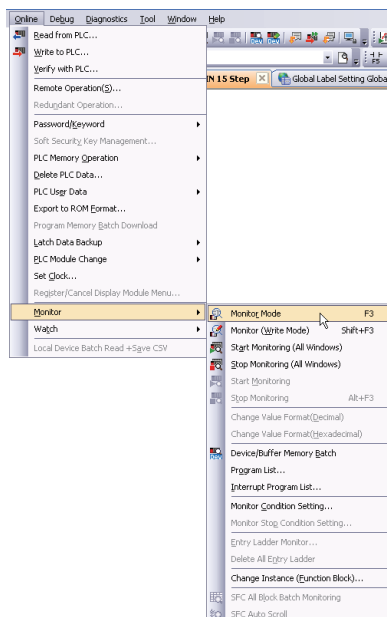
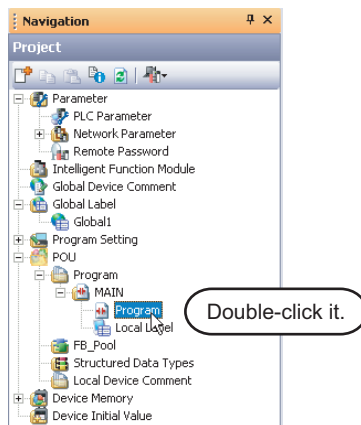
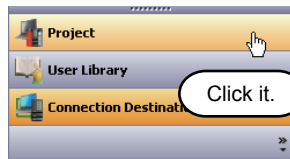

(To the next page)

1. Click "Project" in the view selection area on the Navigation window to display the Project view.

2. Double-click "POU" → "Program" → "MAIN" → "Program" on the Project view to display the [PRG] MAIN screen.

3. Select [Online] → [Monitor] → [Monitor Mode] to switch the [PRG] MAIN screen to the monitoring status.

You can also click  (Monitor Mode) to switch the [PRG] MAIN screen to the monitoring status.

4. Set the programmable controller CPU to RUN.
Set the RUN/STOP switch on the programmable controller CPU to "RUN".

Point

You can switch the programmable controller status between "RUN" and "STOP" using remote operation as follows.

The Settings of the remote operation may vary depending on the programmable controller used.

Refer to the following manual for the details on remote operation:

☞ GX Works2 Version 1 Operating Manual (Common)

Select [Online] → [Remote Operation] to display the Remote Operation screen. You can switch the programmable controller status between "RUN" and "STOP" on this screen.

Connection Channel List information

Displays the connection target information currently set.

Programmable controller Status

Displays the programmable controller CPU status.

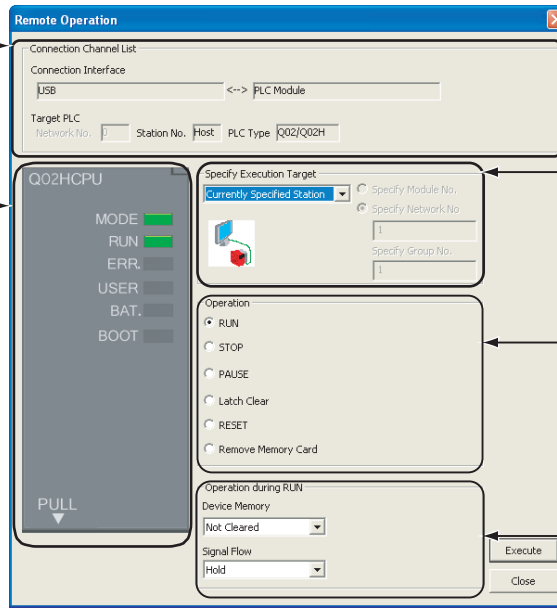

Specify Execution Target

Allows you to set the target station for remote operation. Select "Currently Specified Station" for this example.

Operation

Allows you to select the programmable controller CPU status to be set. Select either "RUN", "PAUSE" or "STOP" for this example.

Operation during RUN

Allows you to set the operations to be executed to the device memory and signal flow when the programmable controller CPU is switched to RUN.

Monitor status display example

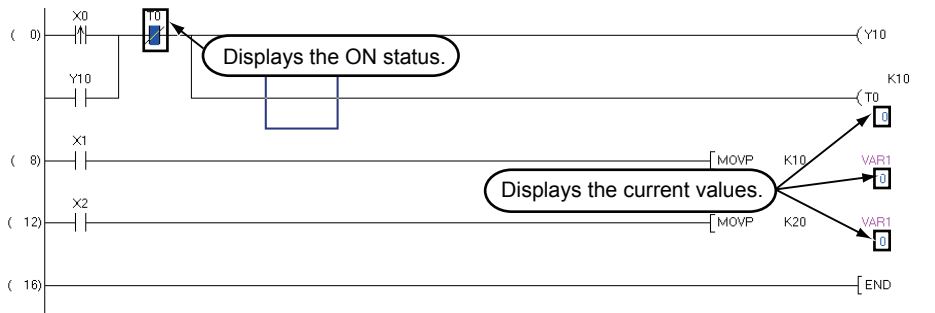

(To the next page)



Monitor status

GX Works2 displays the Monitor status while it is executing the work window monitor.
 The Monitor status disappears when GX Works2 stops all types of monitoring.
 The Monitor status indicates the programmable controller CPU, simulator scan time, RUN/STOP status, etc.

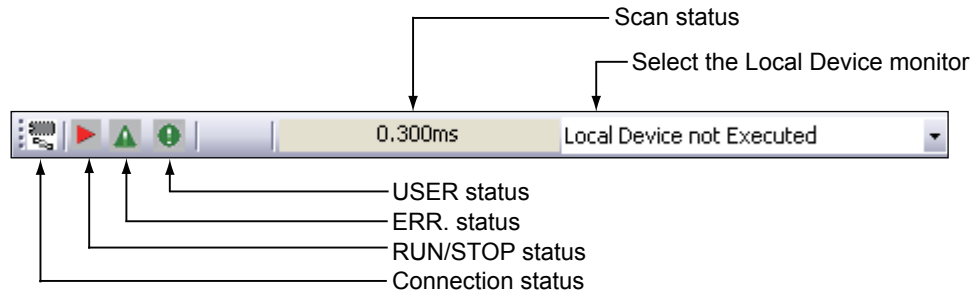

Refer to the following manual for the details on "Monitor status":

GX Works2 Version 1 Operating Manual (Common)

Monitor status display

● **ON/OFF status display**

GX Works2 displays the ON/OFF status as follows during monitoring.

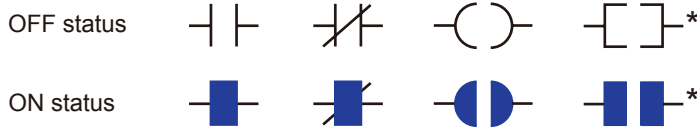

* GX Works2 adopts this display method only for the SET, RST, PLS, PLF, SFT, SFTP and MC instructions and contact type comparison instructions.
 As to monitoring of the RST instruction, GX Works2 displays the ON/OFF status of a reset device.

● **Current value display**

GX Works2 displays the monitored current value as follows.

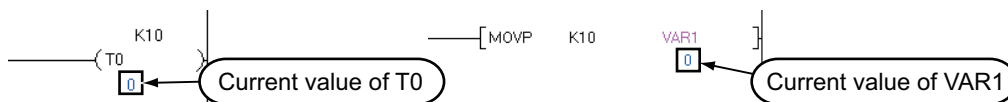

● **Switching of the current value display between decimal and hexadecimal**

You can switch the current value display between decimal and hexadecimal using the following operations.

Operation to switch the current value display to decimal

Select [Online] → [Monitor] → [Change Value Format (Decimal)].

Operation to switch the current value display to hexadecimal

Select [Online] → [Monitor] → [Change Value Format (Hexadecimal)].

Refer to the next page for the test operation.

Test operation

● **Forcing a contact ON/OFF**

Double-click () a monitored contact while pressing the key to force a device in the programmable controller ON/OFF.

● **Changing the current value of a word device**

Double-click () a monitored word device while pressing the key to display the Modify Value screen where you can change the current value.

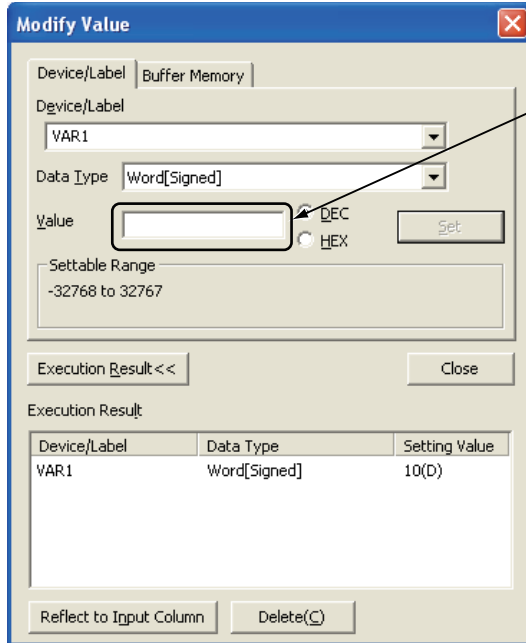

Input the numeric value to be set, and click the button to change the current value to the input numeric value.



5. Turn ON inputs X0, X1 and X2 in the programmable controller, and check the following operations.

You can turn ON inputs X0, X1 and X2 using the test operation above.

- When X0 turns ON, the programmable controller turns ON Y10, and then turns OFF Y10 1 second later.

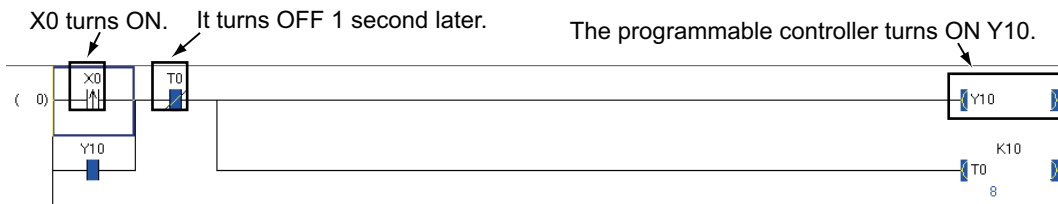

- When X1 turns ON, the programmable controller transfers K10 to VAR1 (device: D0).

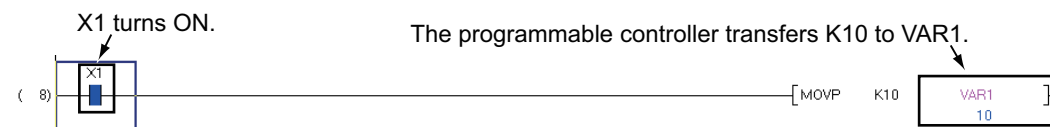

- When X2 turns ON, the programmable controller transfers K20 to VAR1 (device: D0).

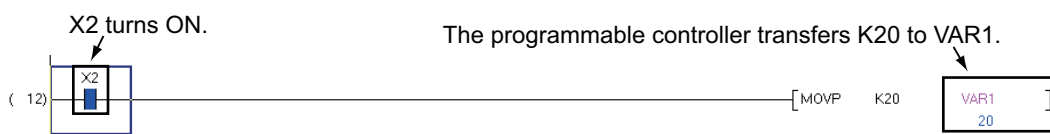

(To the next page)

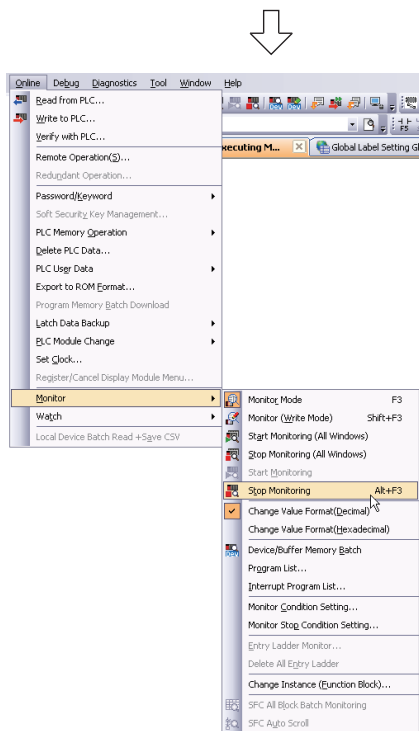

6. Select [Online] → [Monitor] → [Stop Monitoring] to reset the monitor status of the [PRG] MAIN screen.

You can click  (Stop Monitoring) to reset the monitor status of the [PRG] MAIN screen.

7. Set the programmable controller CPU to STOP.

Set the RUN/STOP switch on the programmable controller CPU to "STOP".

You can switch the programmable controller status between "RUN" and "STOP" using remote operation.

For the remote operation, refer to the following.

 "Point" in the step 4

Switch the programmable controller CPU to the "Write" mode when editing the ladders.

Refer to the following manual for details of the "Overwrite" mode, "Insert" mode, "Write" mode and "Read" mode.

 3.2.6 Creating a program

3.4.2 Batch monitoring of device values

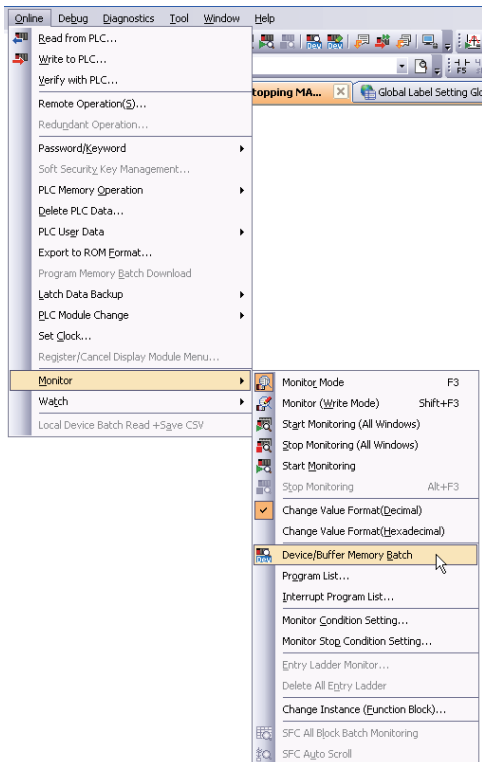

1. Select [Online] → [Monitor] → [Device/Buffer Memory Batch] to display the Device/Buffer Memory Batch Monitor screen.

Or click (Device/Buffer Memory Batch Monitor) to display the Device/Buffer Memory Batch Monitor screen.



Setting

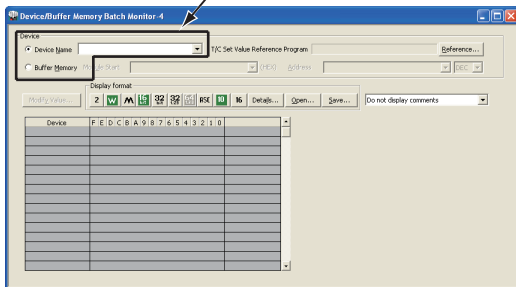

2. Set a device to be monitored. Select D0 in this example.

Setting of "Device"

- Device : Select "Device Name".
- Device Name : D0

3. Click the button to display the Display Format screen.

Restrictions!

Set a device name to be monitored.
Label Name is not available.



(To the next page)

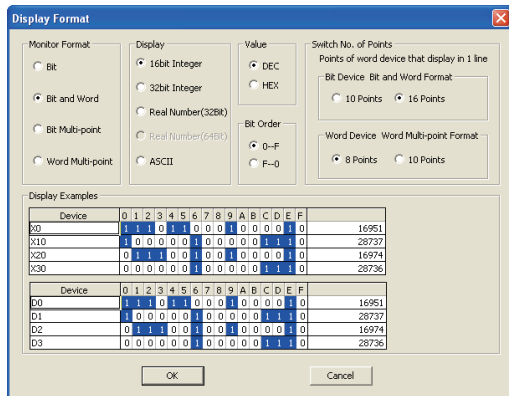

4. Set the Display Format of the device to be monitored.

Setting on the Display Format screen

- Monitor Format : Bit and Word
- Display : 16 bit Integer
- Value : DEC
- Bit Order : 0-F
- Switch No. of Points : Bit Device Bit and Word Format 16 Points
Word Device Word Multi-point Format 8 Points

After the setting, click the button to close the Display Format screen.

Refer to the following manual for the details on Display Format.

GX Works2 Version 1 Operating Manual (Common)

Point

- You can save the contents set on the Display Format screen. When the monitoring screen is opened again, the contents set previously on the "Display Format" screen will not be displayed. (The default setting will be displayed.) To display the previous setting, you can save the setting to a file, and read the file. To save the setting, click button on the Device/Buffer Memory Batch Monitor screen. To read the saved setting, click button on the Device/Buffer Memory Batch Monitor screen.
- You can set the data display format also on the Device/Buffer Memory Batch Monitor screen. For setting the display format, click the "Display Format" button on the Device/Buffer Memory Batch Monitor screen. The contents of setting are reflected on the Display Format screen.

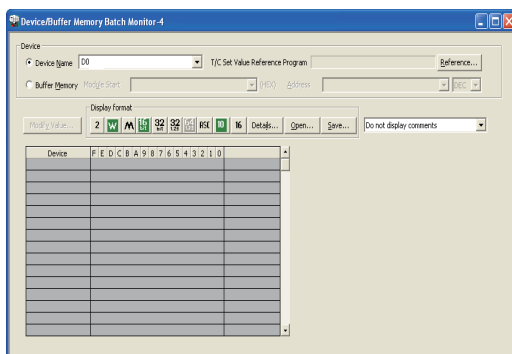



(To the next page)

5. Click (Start Monitoring) on the Ladder toolbar to start monitoring.

6. Set the programmable controller CPU to RUN. Set the RUN/STOP switch on the programmable controller CPU to "RUN".

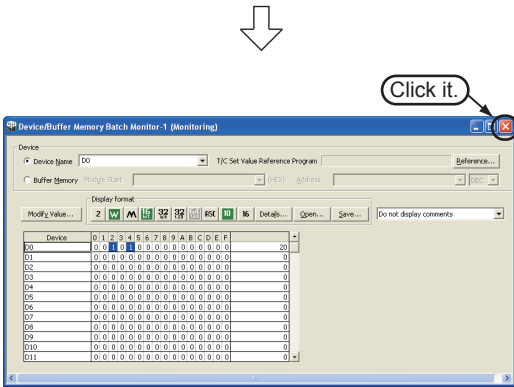
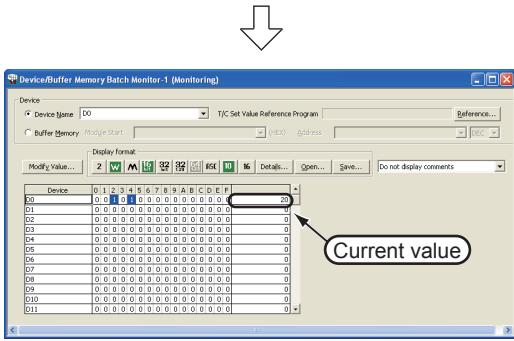
| | |
|---|--|
| 1 | OVERVIEW |
| 2 | CREATED PROGRAM AND SYSTEM CONFIGURATION |
| 3 | CREATING A PROGRAM OF LADDER |
| 4 | CREATING A PROGRAM OF SFC |



7. Click  (Stop Monitoring) on the Ladder toolbar to stop monitoring.
Monitored values remain even after GX Works2 stops monitoring.

8. Click  on the screen to close the Device/ Buffer Memory Batch Monitor screen.

9. Set the programmable controller CPU to STOP.
Set the RUN/STOP switch on the programmable controller CPU to "STOP".
You can switch the programmable controller status between "RUN" and "STOP" using remote operation.
For the remote operation, refer to the following.

 "Point" in the 3.4.1

Point

- **Opening two or more Device/Buffer Memory Batch Monitor screens**
You can open two or more Device/Buffer Memory Batch Monitor screens.
The screen number is indicated at the end of the screen title.

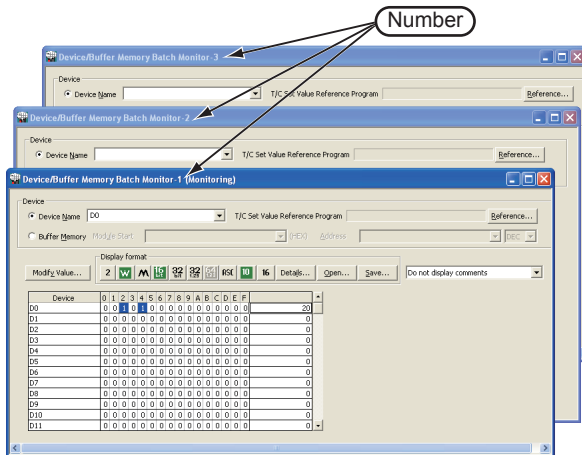



(To the next page)

● **Changing the current value**

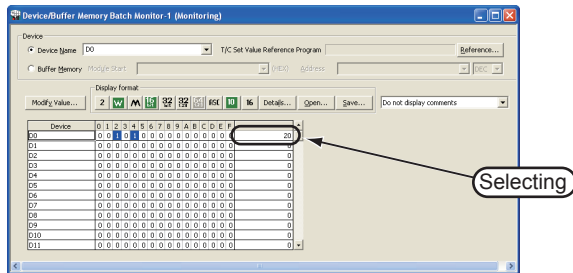
Click the **Modify Value...** button on the **Device/Buffer Memory Batch Monitor** screen to display the **Modify Value** screen which allows you to change the current value.

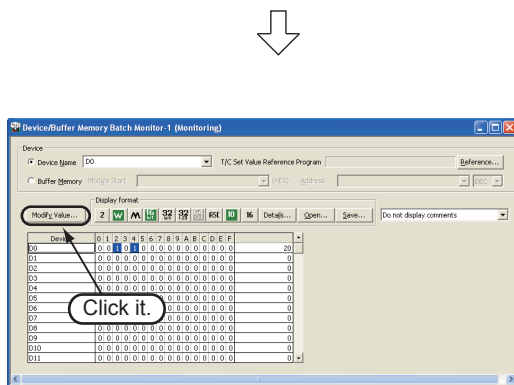

1. Select a device whose current value is to be changed.



2. Click the **Modify Value...** button to display the **Modify Value** screen.
Or click  (Modify Value) to display the **Modify Value** screen.

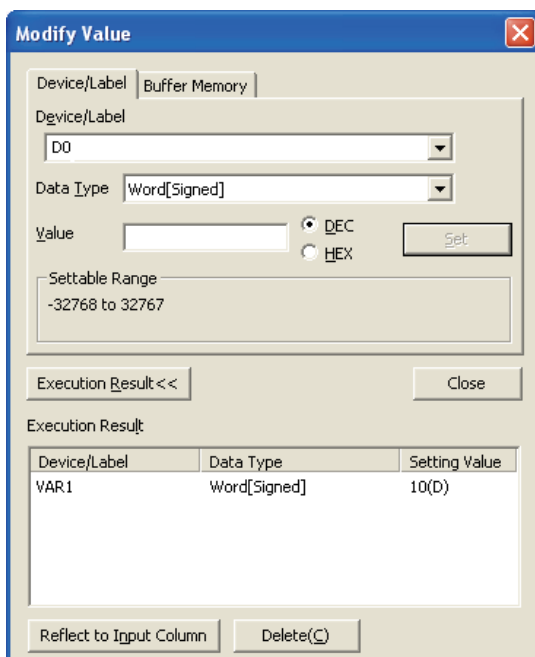

3. Change the current value.
For the change procedure, refer to the following.
 "Point" in the 3.4.1

| | |
|---|--|
| 1 | OVERVIEW |
| 2 | CREATED PROGRAM AND SYSTEM CONFIGURATION |
| 3 | CREATING A PROGRAM OF LADDER |
| 4 | CREATING A PROGRAM OF SFC |

3.5 Diagnosing the programmable controller

You can check the programmable controller RUN/STOP status and error status.

Refer to the following manual for the details on Network Diagnostics, Ethernet Diagnostics and CC-Link IE Control Diagnostics.

GX Works2 Version 1 Operating Manual (Common)

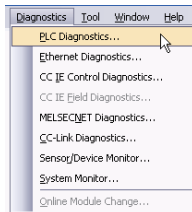

1. Select [Diagnostics] → [PLC Diagnostics] to display the PLC Diagnostics screen.

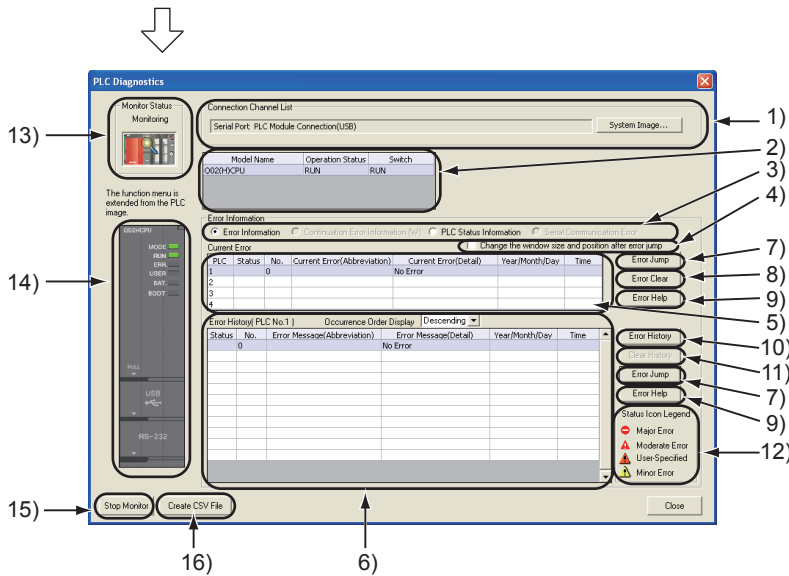

| No. | Item | Description |
|-----|---|---|
| 1) | Connection Channel List | Connection Channel List: Displays the information on connection between the personal computer and the programmable controller CPU. System Image: Displays visually the Connection Channel List. |
| 2) | CPU information of connected station | Displays the model name, operation status and switch status. |
| 3) | Displayed information selection | Select a radio button to display Error Information (Current Error and Error History)/Continuation Error Information/PLC Status Information/Serial Communication Error. |
| 4) | Setting for Error Jump | Check this check box to reduce the PLC Diagnostics screen size and adjust the display position at the time of Error Jump. |
| 5) | Current Error | Displays the current CPU error information. |
| 6) | Error History | Displays the error history. |
| 7) | Error Jump | Jumps to the ladder step number which contains the error corresponding to the currently selected error number. |
| 8) | Error Clear | Clears the error information displayed in "Current Error". |
| 9) | Error Help | Displays the explanation window for the currently selected error number. |
| 10) | Error History | Displays the latest error history. |
| 11) | Clear History | Deletes the error history list in "Error History". |
| 12) | Status Icon Legend | Indicates icons corresponding to errors displayed in the "Status" column of the "Error Information". |
| 13) | Monitor Status | Indicates the monitoring status (executed or stopped). |
| 14) | Programmable controller CPU information | Displays the programmable controller CPU status. |
| 15) | Stop Monitor | Starts or stops monitoring. |
| 16) | Create CSV File | Saves the error information to a CSV file. |

2. Click the button to close the PLC Diagnostics screen.

3.6 Reading a Project from programmable controller

You can read data to a project from the programmable controller CPU selected as the connection destination in Section 3.3.1.

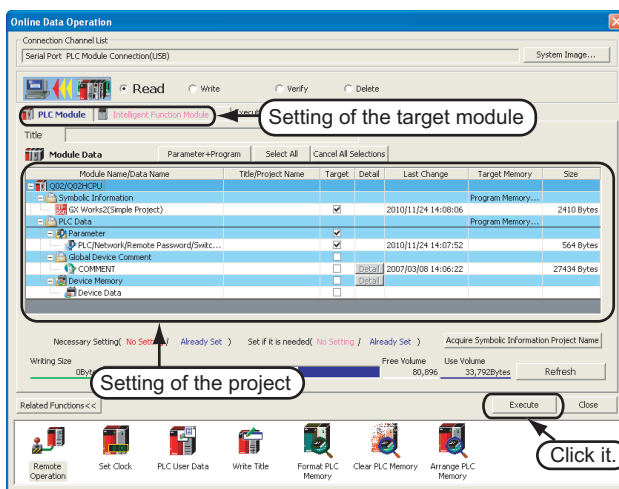
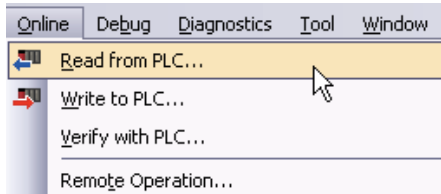

Setting of the target module

- Target module: Select <<PLC Module>>.

Setting of the project

- Symbolic Information : Select "Program Memory/Device Memory" in "Target Memory", and check "GX Works2 (Simple Project)" in "Target".
"Symbolic Information" contains program files and variables.
- PLC Data : Select "Program Memory/Device Memory" in "Target Memory", and check "PLC/Network/Remote Password/Switch Setting" in "Target". *1
Do not check "Global Device Comment" and "Device Memory".

*1: If you have checked desired items for the Write to PLC setting, such items are checked as the default for the Read from PLC setting.

Restrictions!

In the case of FXCPU

- When labels are used, data can be read from the FXCPU only in the FX3U and FX3UC Series version 3.00 or later. When data cannot be read from the FXCPU, carefully store projects written in the programmable controller.

Point

Check the following when not using labels:

- Program (program file)
- Parameter

Point

If a program or parameters already exist in the GX Works2, the following screen appears. Click the or button to overwrite the existing program or parameters. When you click the button, GX Works2 overwrite the existing program or parameters without displaying the overwrites confirmation screen for other data.

When symbolic information already exists

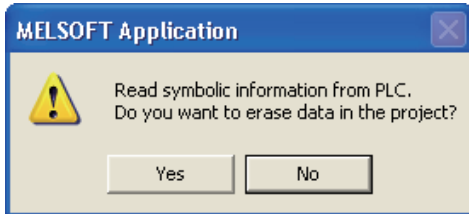

When parameters already exist

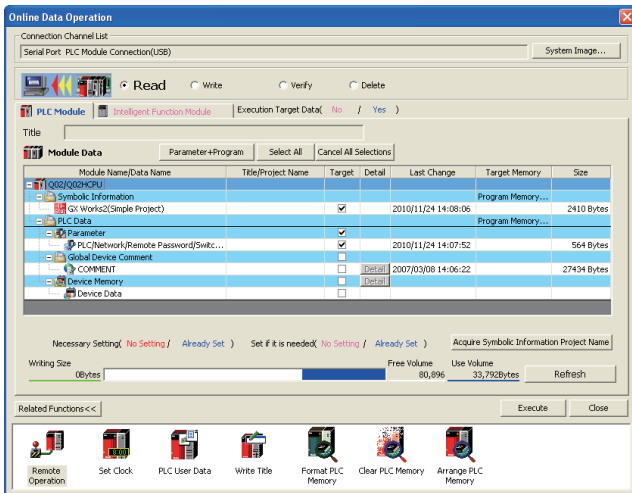
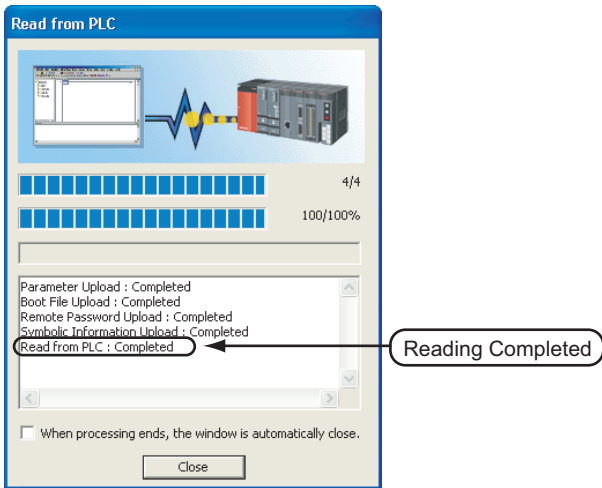
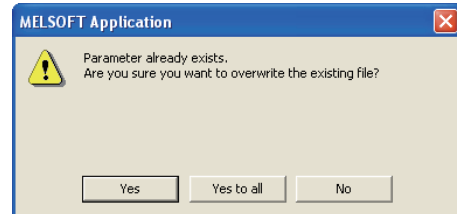

3. The left screen is displayed during reading.

When reading is finished, "Read from PLC: Completed" appears.

Click the button to close the Read from PLC screen.

4. Click the button to close the Online Data Operation screen.

3.7 Printing

You can print programs and parameters created using GX Works2 in a printer. The print function consists of Batch print and print. This section explains print. For details of printing, refer to the following manual.

 GX Works2 Version 1 Operating Manual (Common)

3.7.1 Setting the printer

The printer which prints is set up.

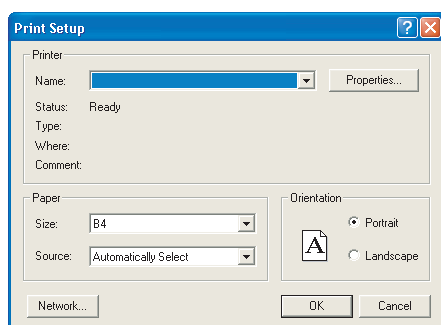
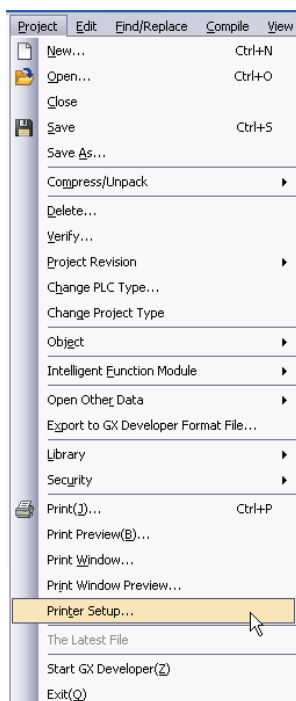

1. Select [Project] → [Printer Setup] to display the Printer Setup screen.

2. Select the Printer, Paper size, Orientation, etc. After the setting, click the button to close the Printer Setup screen.

3.7.2 Previewing a program

You can display a program in the image of printing.

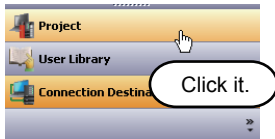

1. Click "Project" in the view selection area on the Navigation window to display the Project view.

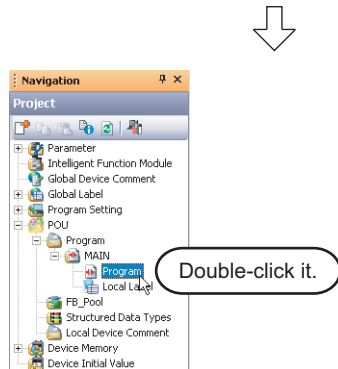

2. Display a program.

Double-click "POU" → "Program" → "MAIN" → "Program" on the Project view to display the [PRG] MAIN screen.

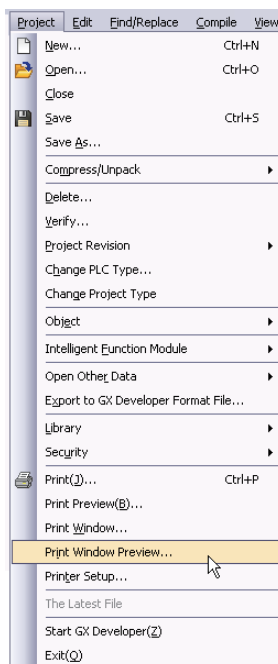
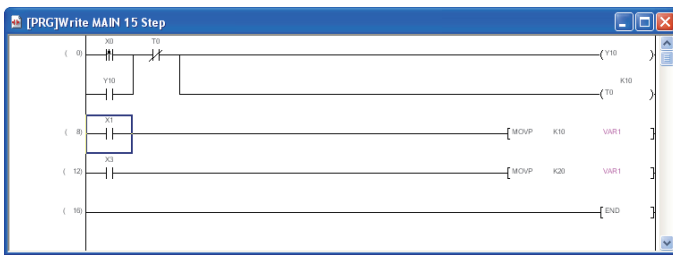

3. Select [Project] → [Print Window Preview] to display the Print Window Preview (Ladder) screen.

(To the next page)

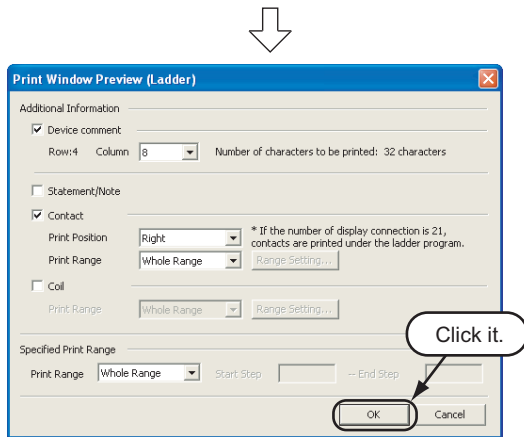

4. Click the **OK** button to determine the setting and display the Print Window Preview screen.

In this example, the Print Window Preview (Ladder) screen remains in the initial setting.

For details of the setting on the Print Window Preview (Ladder) screen, refer to the following manual.

GX Works2 Version 1 Operating Manual (Common)

5. After checking the contents, click the **Print** button to print the program.
Click the **Close** button to close the Print Window Preview screen.

Click button to print the program.

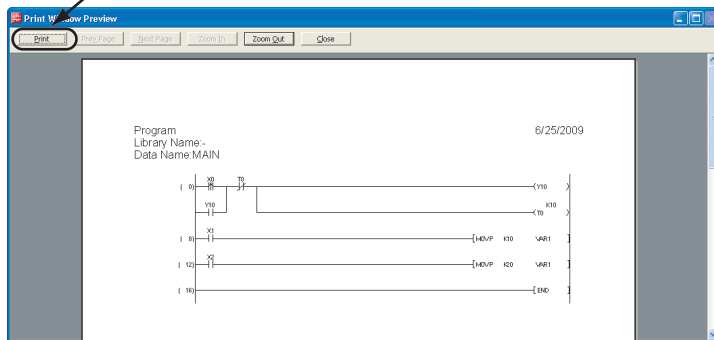

| | |
|---|--|
| 1 | OVERVIEW |
| 2 | CREATED PROGRAM AND SYSTEM CONFIGURATION |
| 3 | CREATING A PROGRAM OF LADDER |
| 4 | CREATING A PROGRAM OF SFC |

3.7.3 Printing a program

1. Display a program.

For the display procedure, refer to the following.

☞ 3.7.2 Previewing a program

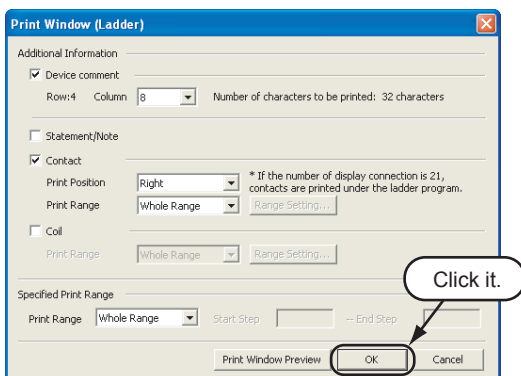
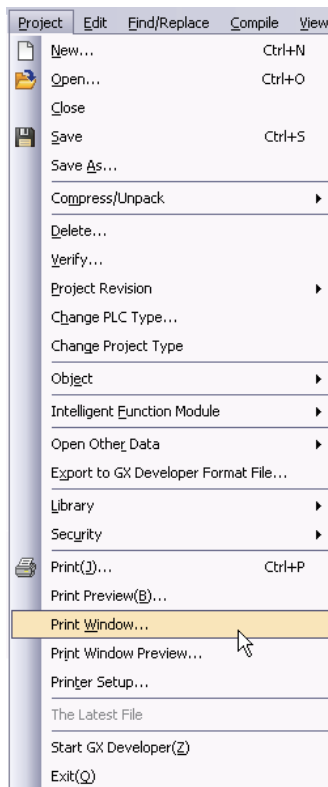
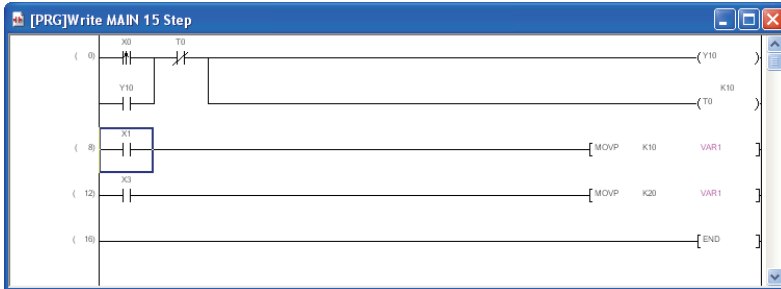

2. Select [Project] → [Print Window] to display the Print Window (Ladder) screen.

3. Click the button to determine the setting and start printing.

In this example, the Print Window (Ladder) screen remains in the initial setting.

For details of the setting on the Print Window (Ladder) screen, refer to the following manual.

☞ GX Works2 Version 1 Operating Manual (Common)

3.7.4 Previewing a PLC Parameter

You can display PLC Parameter in the image of printing.

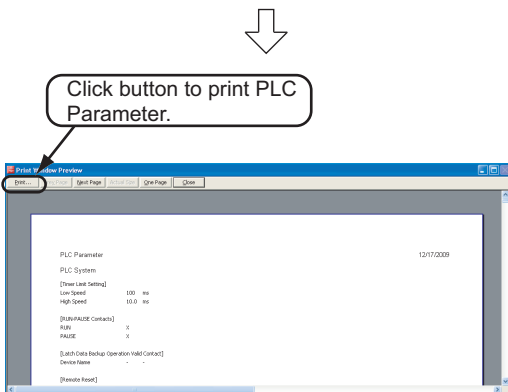
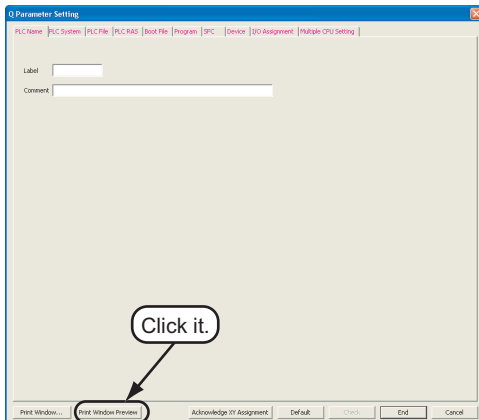
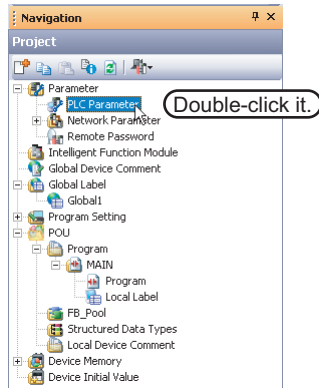

1. Display PLC parameters.

Double-click "Parameter" → "PLC Parameter" on the Project view to display the Q Parameter Setting screen.

2. Click the **Print Window Preview** button.

3. After checking the contents, click the **Print...** button to print PLC Parameter.

Click the **Close** button to close the Print Window Preview screen.

3.7.5 Printing a PLC Parameter

1. Display a PLC Parameter.
For the display procedure, refer to the following.
 3.7.4 Previewing a PLC Parameter
2. Click the **Print Window...** button.

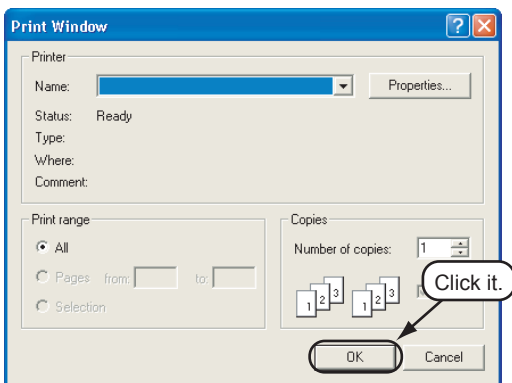
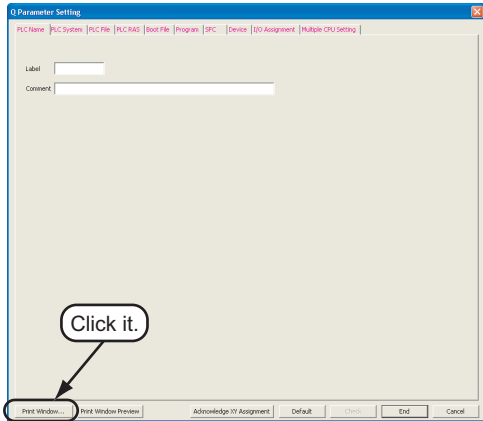

3. Click the **OK** button to start printing.

3.8 Saving a Project

You can save a project.

When saving a newly created project, use the menu item [Save as].

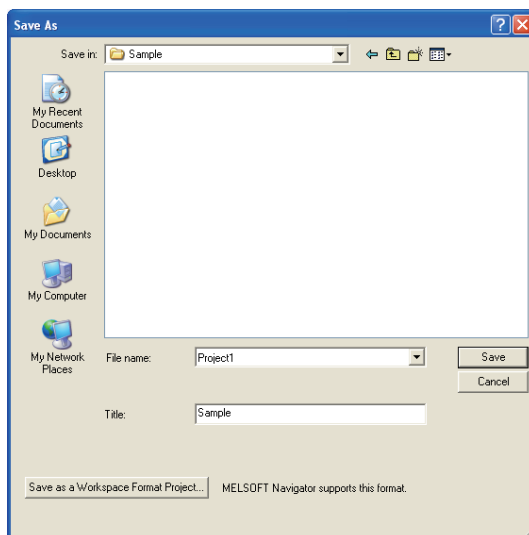
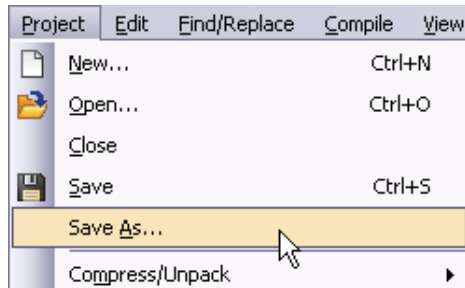

1. Select [Project] → [Save As] to display the Save As screen.

2. Set "Save Location", "Workspace Name", "Project Name", "Title", etc.

After the setting, click the button to save the project (program).

Refer to the following manual for the details:

 GX Works2 Version 1 Operating Manual (Common)

Settings

- Save in : Specify the save destination folder.
- File name : Specify the file name.
- Title : Specify the title.
You can save a project without specifying a title.

Restrictions!

- Input within 128 characters to "Title".
- Make sure that the total characters of "Save Folder Path", "Workspace Name" and "Project Name" is 200 or less.
- You cannot save any project to route directories such as "C:\\" or "D:\\".

3.9 Exiting GX Works2

End the project.

1. Select [Project] → [Exit (Q)] to exit GX Works2.

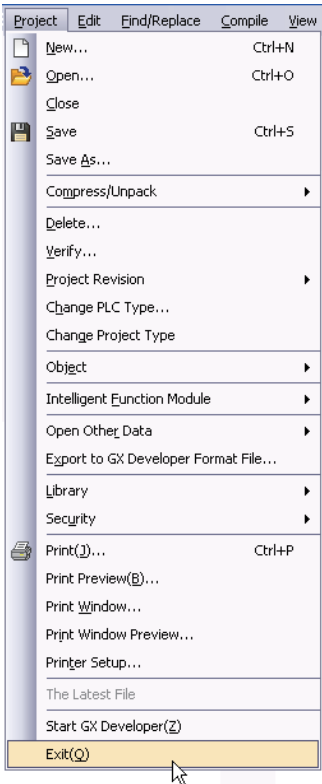

Point

If you have not saved the project, the following message appears.

Click the button to save the project.

Click the button to exit GX Works2 without saving the project.

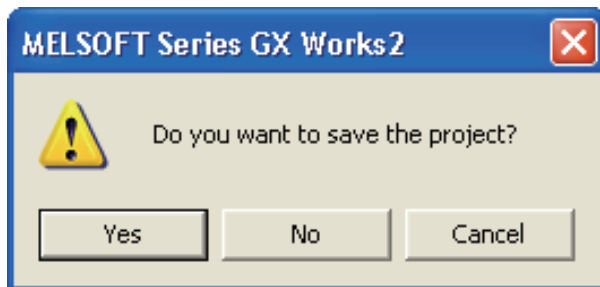



4 CREATING A PROGRAM OF SFC

This chapter explains how to create a program of SFC with a Simple Project through a simple program example.

| | | |
|-----|--|------|
| 4.1 | Created Program | 4-2 |
| 4.2 | Created Program | 4-4 |
| 4.3 | Writing a Project to the programmable controller | 4-27 |
| 4.4 | Monitoring Operations | 4-27 |
| 4.5 | Diagnosing the programmable controller | 4-30 |
| 4.6 | Reading a Project from programmable controller | 4-30 |
| 4.7 | Printing | 4-30 |
| 4.8 | Saving a Project | 4-30 |
| 4.9 | Exiting GX Works2 | 4-30 |

| | |
|---|--|
| 1 | OVERVIEW |
| 2 | CREATED PROGRAM AND SYSTEM CONFIGURATION |
| 3 | CREATING A PROGRAM OF LADDER |
| 4 | CREATING A PROGRAM OF SFC |

4.1 Created Program

This section explains the operations of the program to be created and SFC programs.

4.1.1 Operations of program

This program controls fountain (cycle operation/continuous operation).

- Cycle operation (when X1 is OFF)

When the start button (X0) is pressed, the program will make progress in the sequence "Standby status (S0) → Center lamp (S1) → Center fountain (S2) → Loop line lamp (S3) → Loop line fountain (S4) → Standby status (S0)".

Each output is switched by the timer at every 2 seconds.

- Continuous operation (when X1 is ON)

When the start button (X0) is pressed, the program will make progress in the sequence "Standby status (S0) → Center lamp (S1) → Center fountain (S2) → Loop line lamp (S3) → Loop line fountain (S4) → Center lamp (S1)", and then repeat this sequence.

Each output is switched by the timer at every 2 seconds.

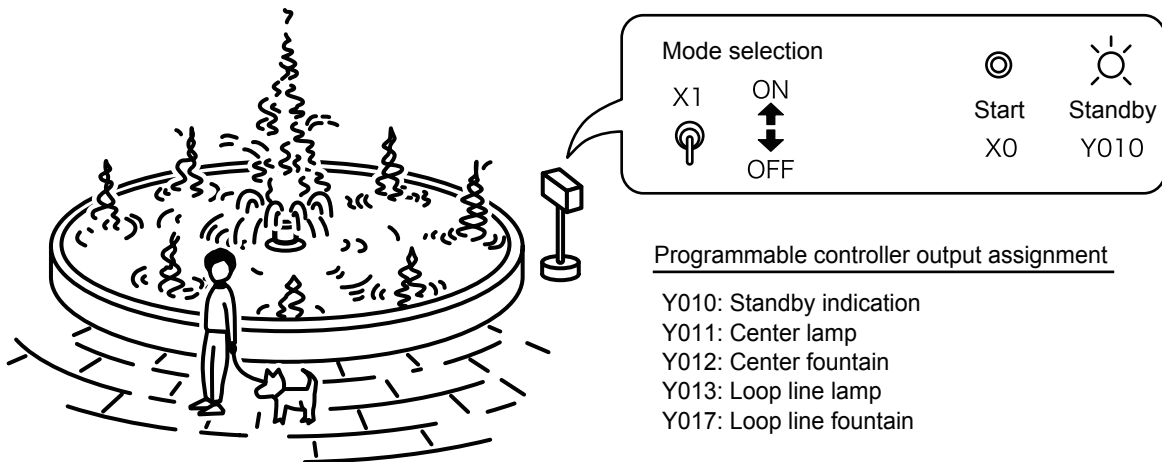

4.1.2 Created Program

■ For QCPU/LCPU

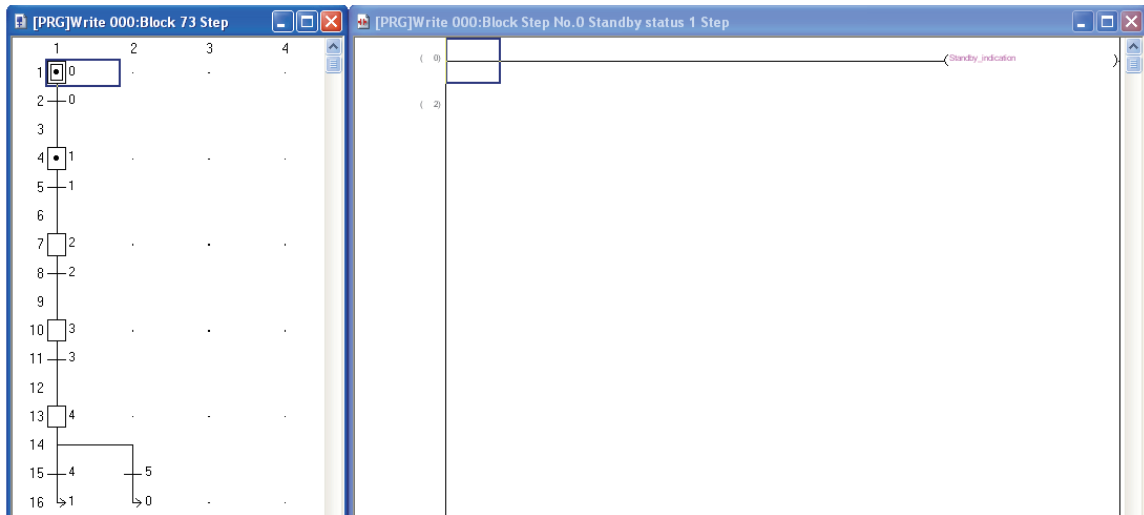

■ For FXCPU

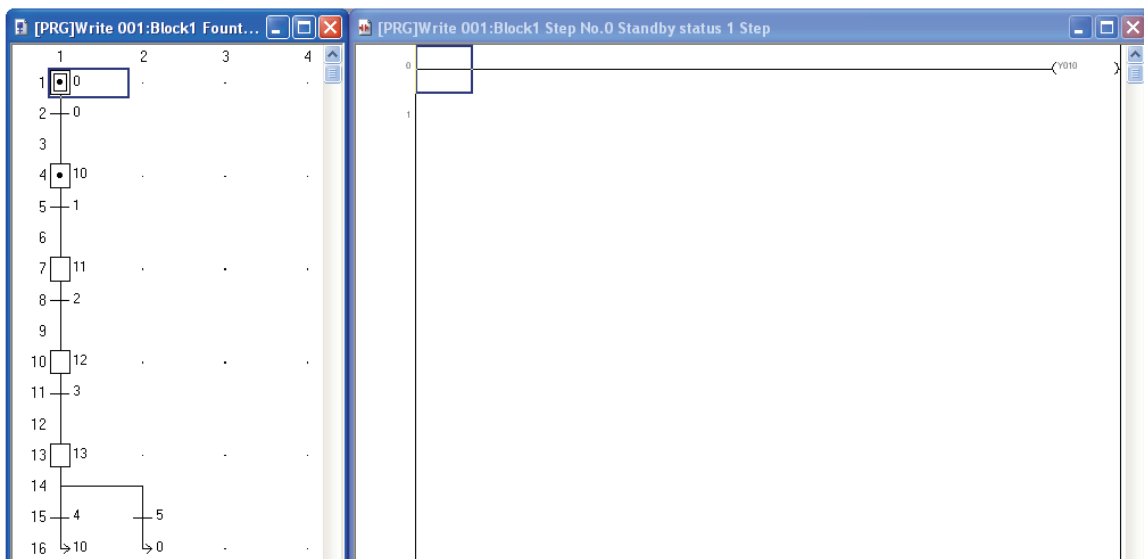
1
OVERVIEW2
CREATED PROGRAM
AND SYSTEM
CONFIGURATION3
CREATING A
PROGRAM OF
LADDER4
CREATING A
PROGRAM OF SFC

4.2 Created Program

Create a project using SFC programs.

4.2.1 Starting GX Works2

For the GX Works2 starting procedure, refer to the following.

 3.2.1 Starting GX Works2

4.2.2 Screen configuration in GX Works2

For the GX Works2 screen configuration, refer to the following.

 3.2.2 Screen configuration in GX Works2

4.2.3 Creating a new project

For the new project creating procedure, refer to the following.
Select SFC as the "programming language".

 3.2.3 Creating a new project

Point

Perform the following when using the FXCPU:

- **Uncheck "Use Label".**
The FXCPU does not support the Label in SFC language.
If it is checked, SFC is not selectable as the "Language".
- **When you select SFC as the "Language" and create a new project, the Block Information Setting screen appears.**
Refer to the following for the setting procedure.

 4.2.7 Creating a program (for FXCPU)

4.2.4 Setting parameters

For the Parameter setting procedure, refer to the following.

 3.2.4 Setting parameters

Refer to the following manuals for the details on Setting parameters.

 GX Works2 Version 1 Operating Manual (Common)

 CPU manual

 CPU programming manual

4.2.5 Setting labels (for QCPU/LCPU)

For the Global Label setting procedure, refer to the following.

 3.2.5 Setting labels

For details of the Global Label and Local Label setting procedures, refer to the following manual.

 GX Works2 Version 1 Operating Manual (Simple Project)

Restrictions!

The FXCPU does not support the Label in SFC language.
Directly input a device.

■ Setting on the Global Label

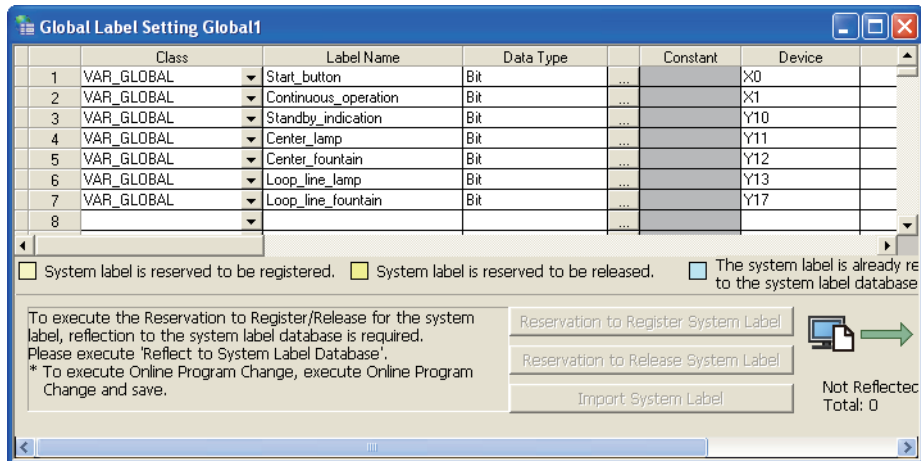

1 OVERVIEW

2 CREATED PROGRAM AND SYSTEM CONFIGURATION

3 CREATING A PROGRAM OF LADDER

4 CREATING A PROGRAM OF SFC

4.2.6 Creating a program (for QCPU/LCPU)

Create the SFC program (for QCPU/LCPU) shown in Section 4.1.2.

You can select the following modes when creating a program.

- "Overwrite" mode or "Insert" mode
- "Write" mode or "Read" mode

Refer to the following manual for details of the "Overwrite" mode, "Insert" mode, "Write" mode and "Read" mode.

 GX Works2 Version 1 Operating Manual (Simple Project)

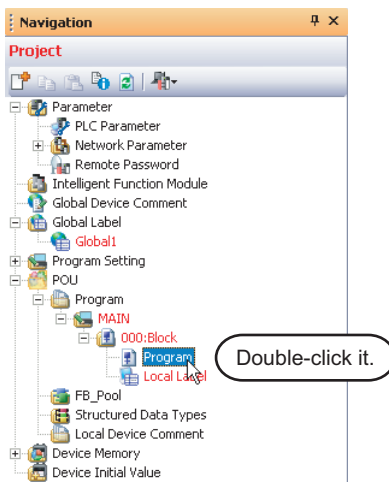

1. Double-click "POU" → "Program" → "MAIN" → "000: Block" → "Program" on the Project view to display the SFC screen for "[PRG] 000: Block".

Point

● SFC diagram/Zoom screen layout

By setting "Options", the SFC diagram and Zoom screen can be displayed together vertically or horizontally.

Select [Tool] → [Options] to display the Options screen.

On the Options screen, select "Program Editor" → "SFC" → "SFC 1" → "Arrange Windows for MELSAP3" → "Arrange", and set the following.

Settings

- Tile SFC and Zoom vertically: Check it.

- Arrange: Select "Tile Horizontally" or "Tile Vertically".

Change the position or size of the window to change over the SFC diagram/Zoom screen layout.

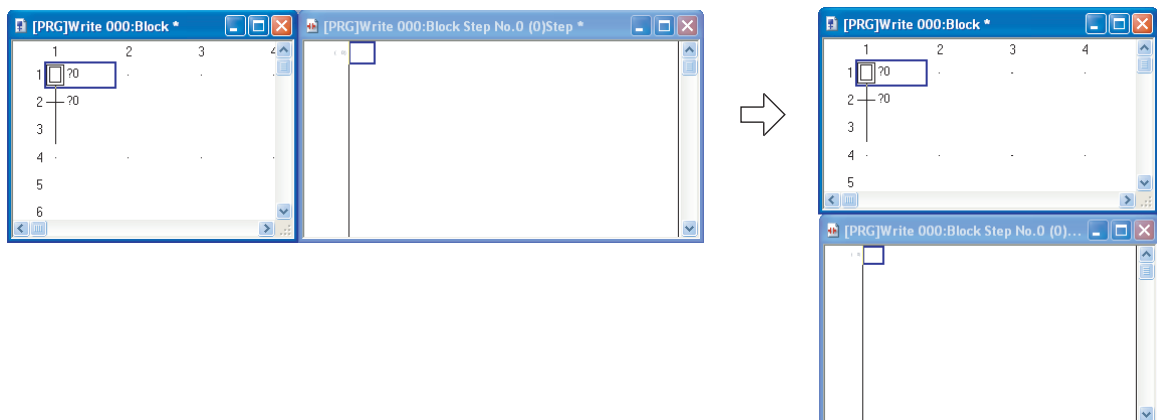

(To the next page)

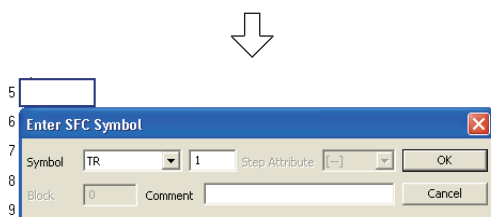
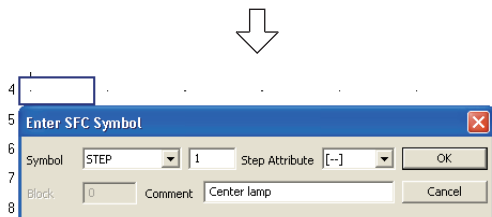
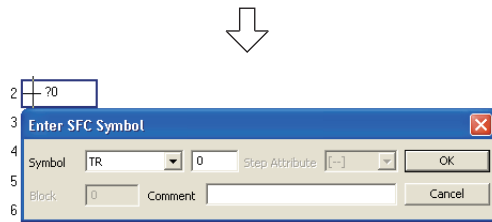
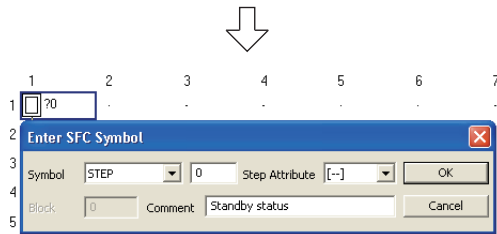

(To the next page)

2. Creating the SFC Diagram (step 0)

Put the cursor in the position "row number 1, column number 1" on the screen, and double-click it to display the Enter SFC Symbol screen.

After setting the items, click the button to move the cursor to the next row.

Settings

- Symbol : STEP/0
- Step Attribute : [--]
- Comment : Standby status

3. Creating the SFC Diagram (Series transition 0)

Put the cursor in the position "row number 2, column number 1" on the screen, and double-click it to display the Enter SFC Symbol screen.

After setting the items, click the button to move the cursor to the next row.

Settings

- Symbol : TR/0
- Comment : blank

4. Creating the SFC Diagram (step 1)

For the creation method, refer to the following. Put the cursor in the position "row number 4, column number 1".

 "Step2" in the 4.2.6

Settings

- Symbol : STEP/1
- Step Attribute : [--]
- Comment : Center lamp

5. Creating the SFC Diagram (Series transition 1)

For the creation method, refer to the following. Put the cursor in the position "row number 5, column number 1".

 "Step3" in the 4.2.6

Settings

- Symbol : TR/1
- Comment : blank

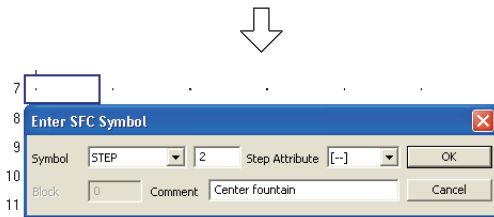

6. Creating the SFC Diagram (step 2)

For the creation method, refer to the following.
Put the cursor in the position "row number 7, column number 1".

☞ "Step2" in the 4.2.6

Settings

- Symbol : STEP/2
- Step Attribute : [--]
- Comment : Center fountain

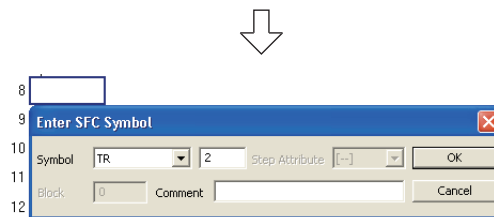

7. Creating the SFC Diagram (Series transition 2)

For the creation method, refer to the following.
Put the cursor in the position "row number 8, column number 1".

☞ "Step3" in the 4.2.6

Settings

- Symbol : TR/2
- Comment : blank

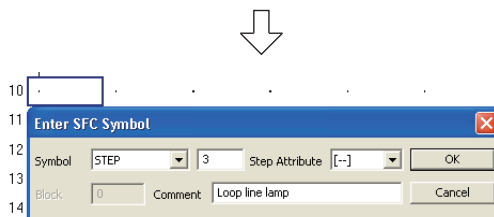

8. Creating the SFC Diagram (step 3)

For the creation method, refer to the following.
Put the cursor in the position "row number 10, column number 1".

☞ "Step2" in the 4.2.6

Settings

- Symbol : STEP/3
- Step Attribute : [--]
- Comment : Loop line lamp

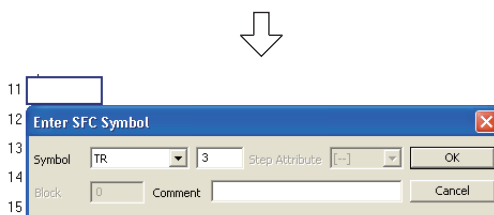

9. Creating the SFC Diagram (Series transition 3)

For the creation method, refer to the following.
Put the cursor in the position "row number 11, column number 1".

☞ "Step3" in the 4.2.6

Settings

- Symbol : TR/3
- Comment : blank

(To the next page)

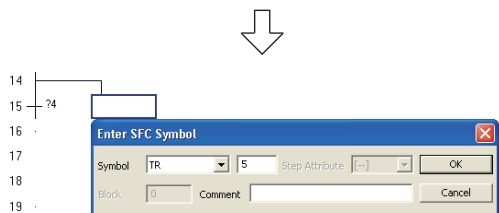
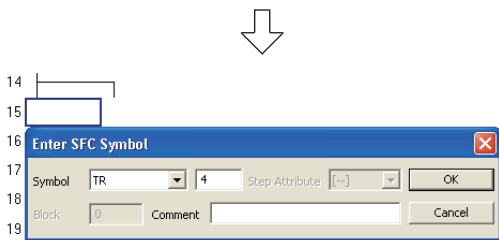
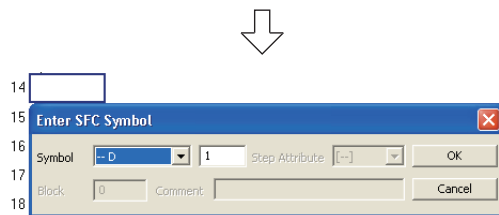
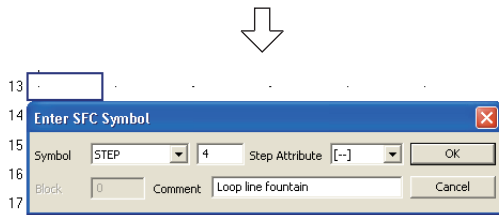

(To the next page)

10. Creating the SFC Diagram (step 4)

For the creation method, refer to the following. Put the cursor in the position "row number 13, column number 1".

☞ "Step2" in the 4.2.6

Settings

- Symbol : STEP/4
- Step Attribute : [--]
- Comment : Loop line fountain

11. Creating the SFC Diagram (Selective branch)

Put the cursor in the position "row number 14, column number 1" on the screen, and double-click it to display the Enter SFC Symbol screen.

After setting the items, click the button to move the cursor to the next row.

Settings

- Symbol : --D/1

12. Creating the SFC Diagram (Series transition 4)

For the creation method, refer to the following. Put the cursor in the position "row number 15, column number 1".

☞ "Step3" in the 4.2.6

Settings

- Symbol : TR/4
- Comment : blank

13. Creating the SFC Diagram (Series transition 5)

For the creation method, refer to the following. Put the cursor in the position "row number 15, column number 2".

☞ "Step3" in the 4.2.6

Settings

- Symbol : TR/5
- Comment : blank

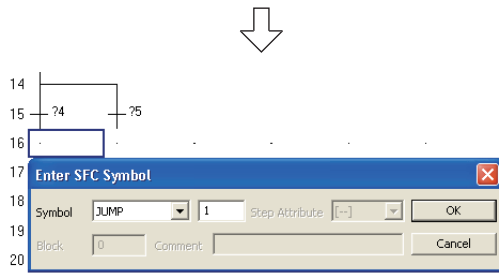

14. Creating the SFC Diagram (Jump to the Continuous operation)

Put the cursor in the position "row number 16, column number 1" on the screen, and double-click it to display the Enter SFC Symbol screen.

After setting "Symbol", click the button to display the jump destination step number.

Settings

- Symbol : JUMP/1

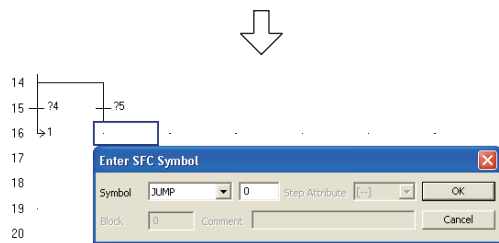

15. Creating the SFC Diagram (jump to the Cycle operation)

Put the cursor in the position "row number 16, column number 2" on the screen, and double-click it to display the Enter SFC Symbol screen.

After setting "Symbol", click the button to display the jump destination step number.

Settings

- Symbol : JUMP/0



↓
(To the next page)

Point

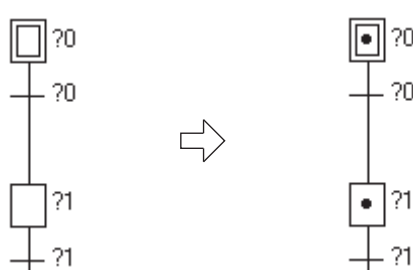
- The step (□) specified as the jump destination will change into (◻)

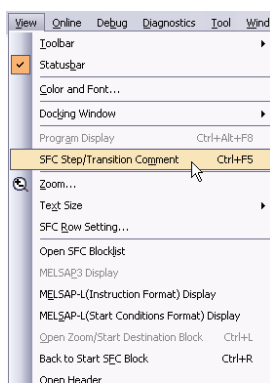

- Perform the following procedure to display comments set on the Enter SFC Symbol screen.
Select [View] → [SFC Step/Transition Comment].

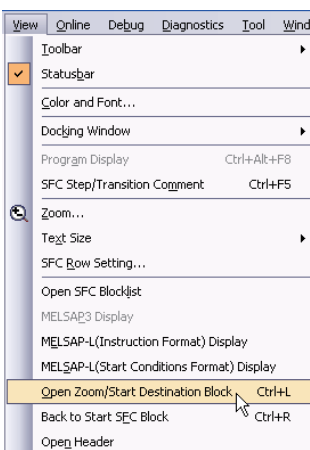
(To the next page)

16. Creating the zoom (operation output of the step 0)

Put the cursor in the zoom block (such as step and serial transition), and then perform the following procedure to display the zoom.

In this case, put the cursor in the step 0.

Select [View] → [Open Zoom/Start Destination Block].

Perform the following to return to the SFC screen:

Select [View] → [Back to Zoom SFC Block].

Create the operation output of the step 0 (standby status), and convert the ladder.

For operation output creation and ladder conversion, refer to the following.

☞ 3.2.6 Creating a program

☞ 3.2.7 Converting ladder blocks

1 OVERVIEW

2 CREATED PROGRAM AND SYSTEM CONFIGURATION

3 CREATING A PROGRAM OF LADDER

4 CREATING A PROGRAM OF SFC

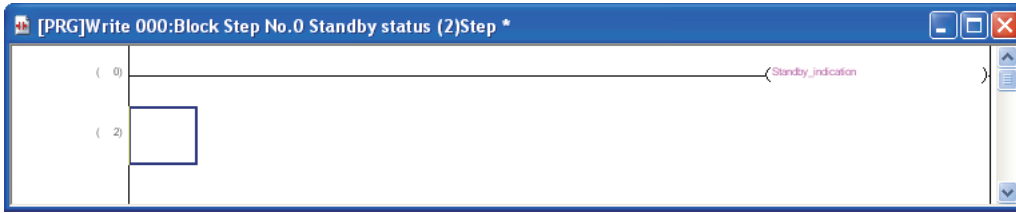

Point!

● The step (□?) whose operation output is created will change into (□)

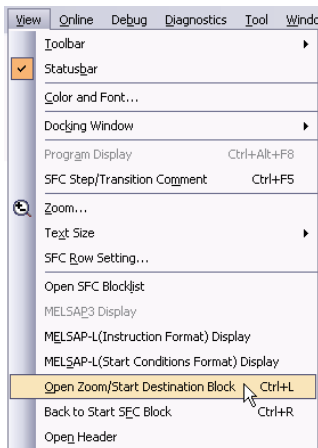
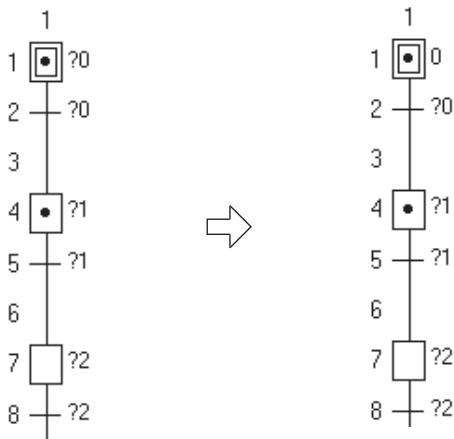

(To the next page)

17. Creating the zoom (Transition condition of series transition 0)

Display the zoom.

For the display method, refer to the following.



☞ "Step16" in the 4.2.6

For operation output creation and ladder conversion, refer to the following.

☞ 3.2.6 Creating a program

☞ 3.2.7 Converting ladder blocks



Point

In the transition condition, the coil instruction accepts only one dummy coil ([TRAN]).
 Click "  " or "  ", and click the button to enter the dummy coil. Then, "[TRAN]" will be entered automatically.



18. Creating the zoom (step1, series transition 1, step2, series transition 2, step3, series transition 3, step4, series transition 4, series transition 5)

For the zoom display and creation methods, refer to the following.

-  "Step16" in the 4.2.6
-  "Step17" in the 4.2.6
-  "Point" in the Step17

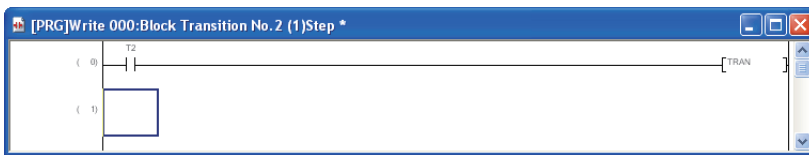
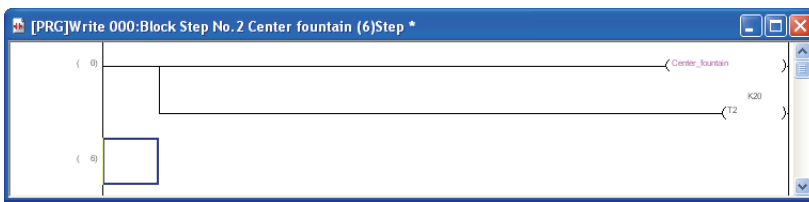
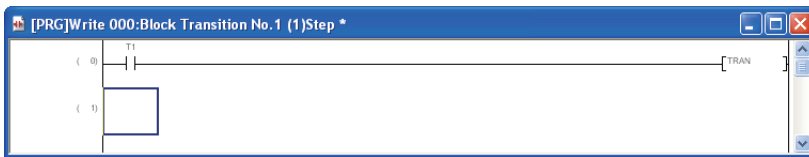
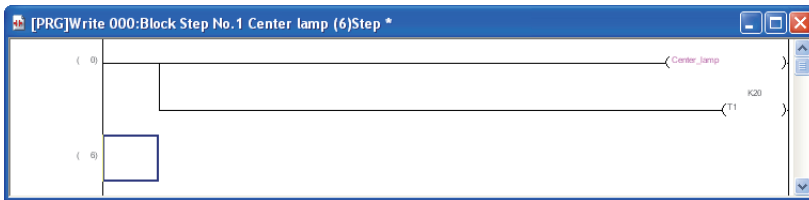

(To the next page)

| | |
|---|--|
| 1 | OVERVIEW |
| 2 | CREATED PROGRAM AND SYSTEM CONFIGURATION |
| 3 | CREATING A PROGRAM OF LADDER |
| 4 | CREATING A PROGRAM OF SFC |

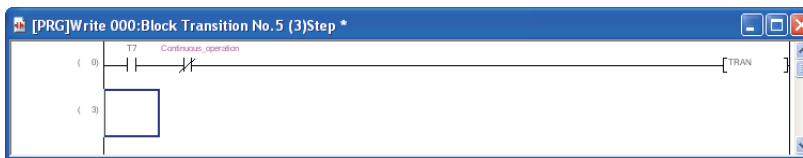
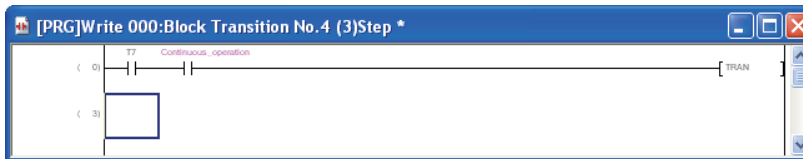
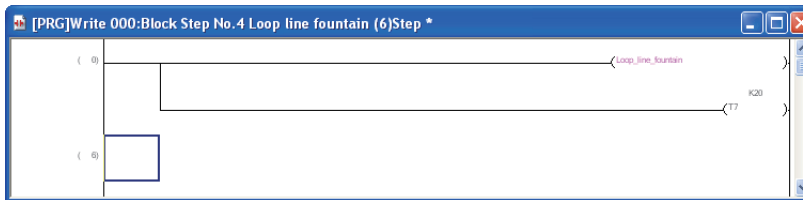
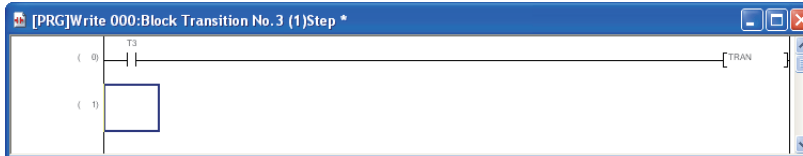
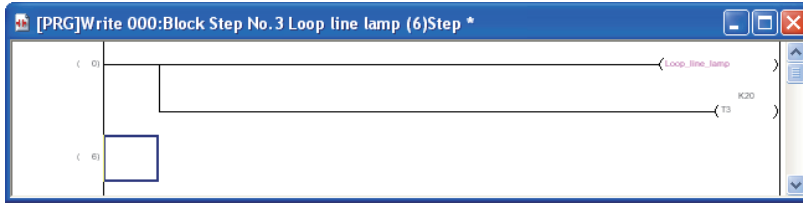

4.2.7 Creating a program (for FXCPU)

Create the SFC program (for FXCPU) shown in Section 4.1.2
You can select the following modes when creating a program.

- "Overwrite" mode or "Insert" mode
- "Write" mode or "Read" mode

Refer to the following manual for details of the "Overwrite" mode, "Insert" mode, "Write" mode and "Read" mode.

 GX Works2 Version 1 Operating Manual (Simple Project)

When you select "SFC" as the "Language" for creating a new project, the Block Information Setting screen appears.

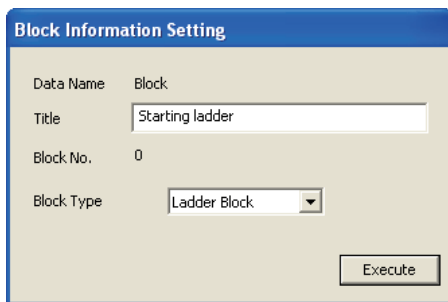

1. Creating a ladder block.

Set "Title" and "Block Type".

After setting, click the  button to close the Block Information Setting screen and add "000: Block Starting ladder" (ladder block) on the Project view screen.

"SFC Block" and "Ladder Block" can be selected as the "Block Type".
When the FXCPU is used, it is necessary to create a ladder for turning ON the SFC program using a ladder block.

Settings

- Title : Starting ladder
- Block Type : Ladder Block

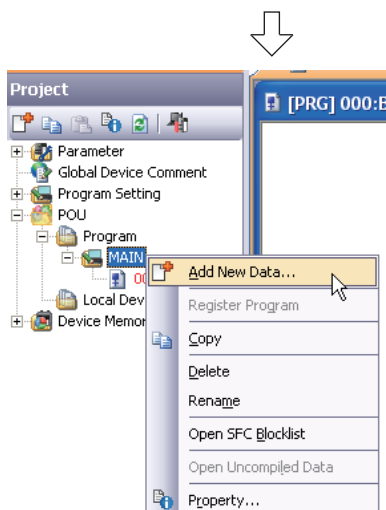
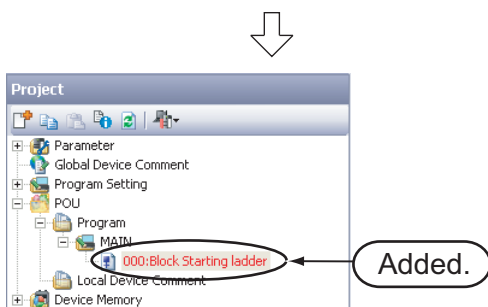

2. Creating the SFC Block

Select "MAIN" on the Project view screen, right-click it, and then select the menu item "Add New Data".

The New Data screen will appear.

(To the next page)

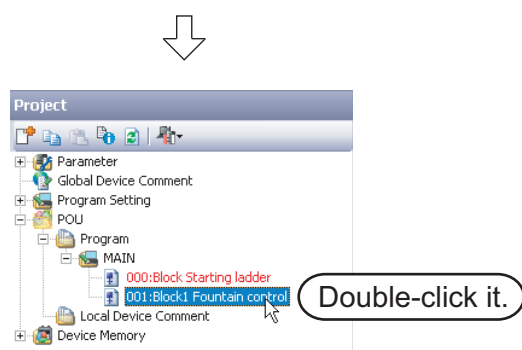
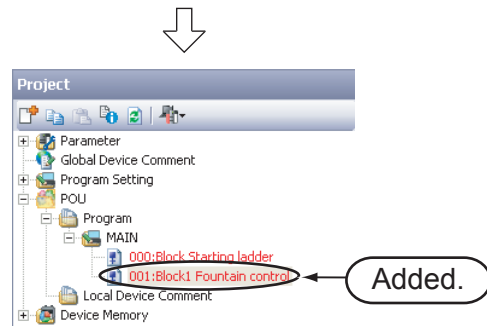
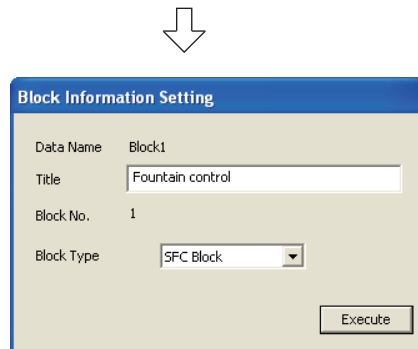
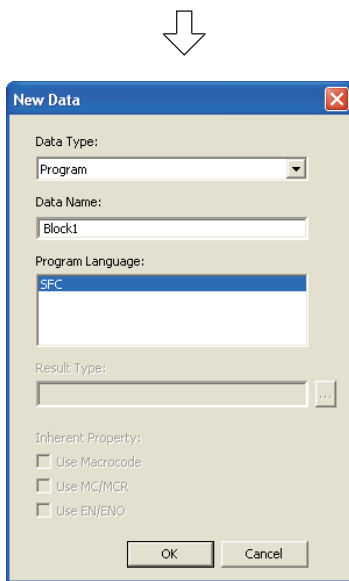

(To the next page)

3. Creating the SFC Block
Set "Data Type" and "Language".
Leave "Data Name" in the initial setting (Block1). After setting, click the button to close the New Data screen and display the Block Information Setting screen.

Settings

- Data Type : Program
- Language : SFC

4. Creating the SFC Block
Set "Title" and "Block Type".
After setting, click the button to close the Block Information Setting screen and add "001: Block1 Fountain control" (SFC block) on the Project view screen.

When using the FXCPU, create an SFC program in this block.

Set to ON the initial step of this block using the ladder block created in "000: Block".

Settings

- Title : Fountain control
- Block Type : SFC Block

5. Creating the SFC Diagram
Double-click "POU" → "Program" → "MAIN" → "001: Block1 Fountain control" on the Project view to display the SFC screen for "[PRG] 001: Block1 Fountain control".

Point

● SFC diagram/Zoom screen layout

By setting "Options", the SFC diagram and Zoom screen can be displayed together vertically or horizontally.

Select [Tool] → [Options] to display the Options screen.

On the Options screen, select "Program Editor" → "SFC" → "SFC 1" → "Arrange Windows for MELSAP3" → "Arrange", and set the following.

Settings

• Tile SFC and Zoom vertically: Check it.

• Arrange: Select "Tile Horizontally" or "Tile Vertically".

Change the position or size of the window to change over the SFC diagram/Zoom screen layout.

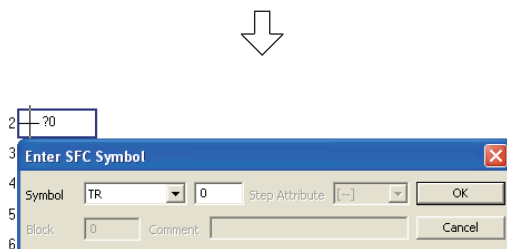
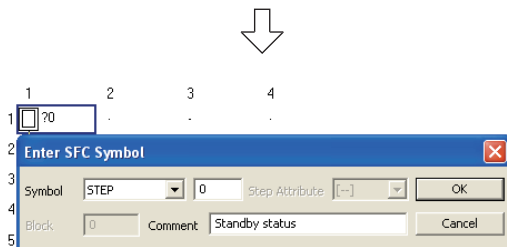
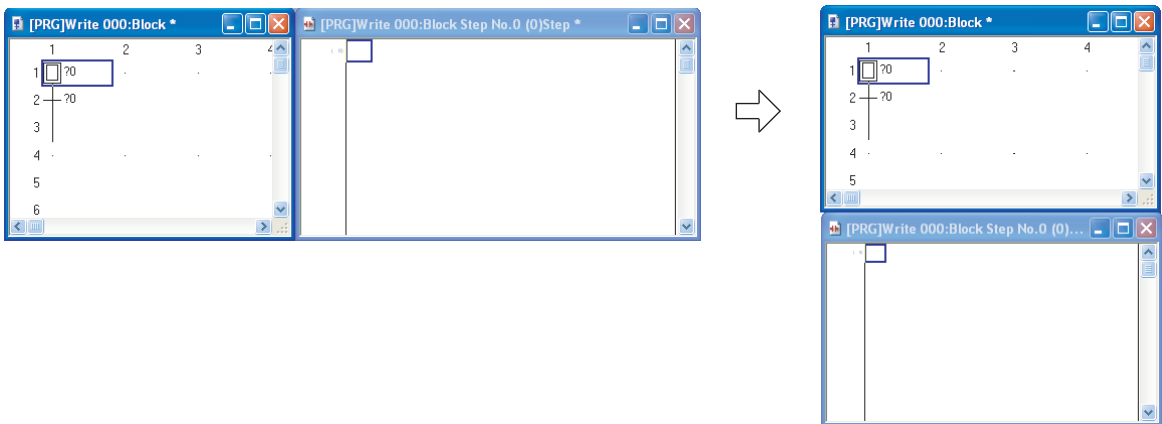

(To the next page)

6. Creating the SFC Diagram (step 0)

Put the cursor in the position "row number 1, column number 1" on the screen, and double-click it to display the Enter SFC Symbol screen.

After setting the items, click the button to move the cursor to the next row.

Settings

- Symbol : STEP/0
- Comment : Standby status

7. Creating the SFC Diagram (Series transition 0)

Put the cursor in the position "row number 2, column number 1" on the screen, and double-click it to display the Enter SFC Symbol screen.

After setting the items, click the button to move the cursor to the next row.

Settings

- Symbol : TR/0



8. Creating the SFC Diagram (step 10)

For the creation method, refer to the following.
Put the cursor in the position "row number 4, column number 1".

"Step6" in the 4.2.7

Settings

- Symbol : STEP/10
- Comment : Center lamp

Restrictions!

● When using the FXCPU, set steps of the SFC program as follows:

- States S0 to S9 are called initial steps (states), and used only as head step numbers of SFC blocks. Accordingly, you can create up to 10 SFC blocks (starting from S0 to S9) when using the FXCPU.
- States S10 and later can be used as general step numbers. However, note that the maximum number of steps in 1 block is 512.
- Each step (state) number can be used only once throughout all blocks.



9. Creating the SFC Diagram (Series transition 1)

For the creation method, refer to the following.
Put the cursor in the position "row number 5, column number 1".

"Step7" in the 4.2.7

Settings

- Symbol : TR/1



10. Creating the SFC Diagram (step 11)

For the creation method, refer to the following.
Put the cursor in the position "row number 7, column number 1".

"Step6" in the 4.2.7

Settings

- Symbol : STEP/11
- Comment : Center fountain



11. Creating the SFC Diagram (Series transition 2)

For the creation method, refer to the following.
Put the cursor in the position "row number 8, column number 1".

"Step7" in the 4.2.7

Settings

- Symbol : TR/2



(To the next page)

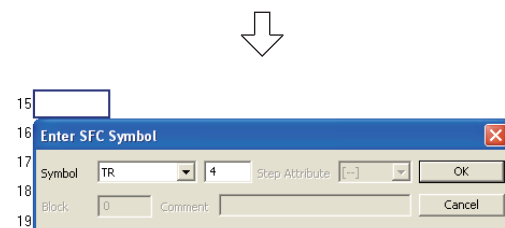
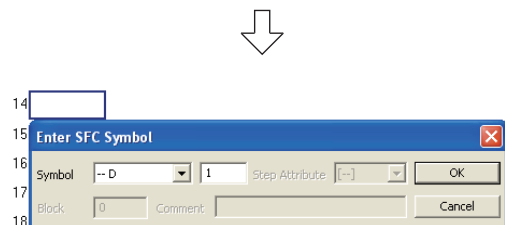
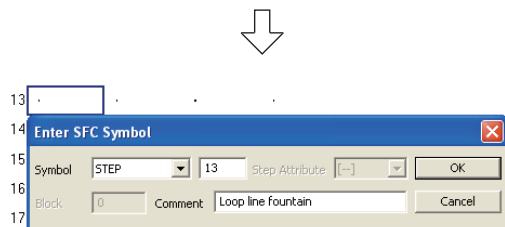
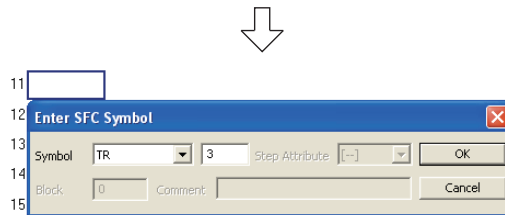
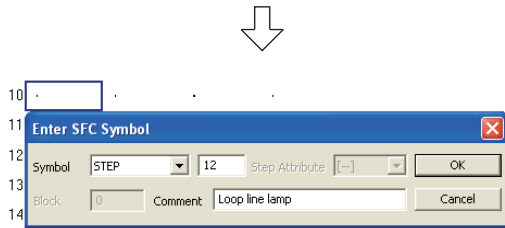

(To the next page)

12. Creating the SFC Diagram (step 12)

For the creation method, refer to the following. Put the cursor in the position "row number 10, column number 1".

"Step6" in the 4.2.7

Settings

- Symbol : STEP/12
- Comment : Loop line lamp

13. Creating the SFC Diagram (Series transition 3)

For the creation method, refer to the following. Put the cursor in the position "row number 11, column number 1".

"Step7" in the 4.2.7

Settings

- Symbol : TR/3

14. Creating the SFC Diagram (step 13)

For the creation method, refer to the following. Put the cursor in the position "row number 13, column number 1".

"Step6" in the 4.2.7

Settings

- Symbol : STEP/13
- Comment : Loop line fountain

15. Creating the SFC Diagram (Selective branch)

Put the cursor in the position "row number 14, column number 1" on the screen, and double-click it to display the Enter SFC Symbol screen.

After setting the items, click the button to move the cursor to the next row.

Settings

- Symbol : --D/1

16. Creating the SFC Diagram (Series transition 4)

For the creation method, refer to the following. Put the cursor in the position "row number 15, column number 1".

"Step7" in the 4.2.7

Settings

- Symbol : TR/4

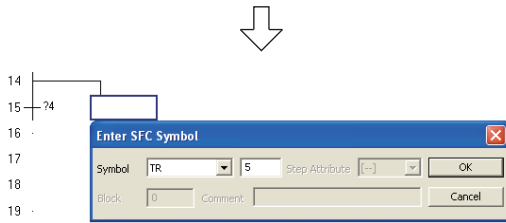

17. Creating the SFC Diagram (Series transition 5)

For the creation method, refer to the following.
Put the cursor in the position "row number 15, column number 2".

☞ "Step7" in the 4.2.7

Settings

- Symbol : TR/5

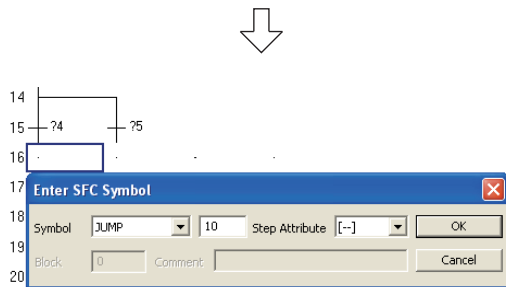

18. Creating the SFC Diagram (Jump to the Continuous operation)

Put the cursor in the position "row number 16, column number 1" on the screen, and double-click it to display the Enter SFC Symbol screen.

After setting "Symbol", click the button to display the jump destination step number.

Settings

- Symbol : JUMP/1
- Step Attribute : [-]

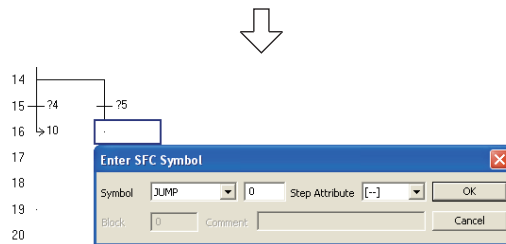

19. Creating the SFC Diagram (jump to the Cycle operation)

Put the cursor in the position "row number 16, column number 2" on the screen, and double-click it to display the Enter SFC Symbol screen.

After setting "Symbol", click the button to display the jump destination step number.

Settings

- Symbol : JUMP/0
- Step Attribute : [-]

☞
(To the next page)



Point!

- The step () specified as the jump destination will change into ().

- Perform the following procedure to display comments set on the Enter SFC Symbol screen. Select [View] → [SFC Step/Transition Comment].



(To the next page)

| | |
|---|--|
| 1 | OVERVIEW |
| 2 | CREATED PROGRAM AND SYSTEM CONFIGURATION |
| 3 | CREATING A PROGRAM OF LADDER |
| 4 | CREATING A PROGRAM OF SFC |

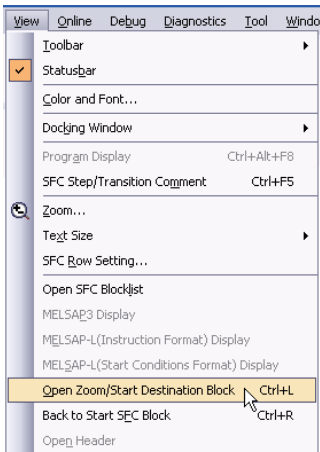

20. Creating the zoom (operation output of the step 0)

Put the cursor in the zoom block (such as step and serial transition), and then perform the following procedure to display the zoom. In this case, put the cursor in the step 0.

Select [View] → [Open Zoom/Start Destination Block].

Perform the following to return to the SFC screen:

Select [View] → [Back to Zoom SFC Block].

Create the operation output of the step 0 (standby status), and convert the ladder.

For operation output creation and ladder conversion, refer to the following.

☞ 3.2.6 Creating a program

☞ 3.2.7 Converting ladder blocks

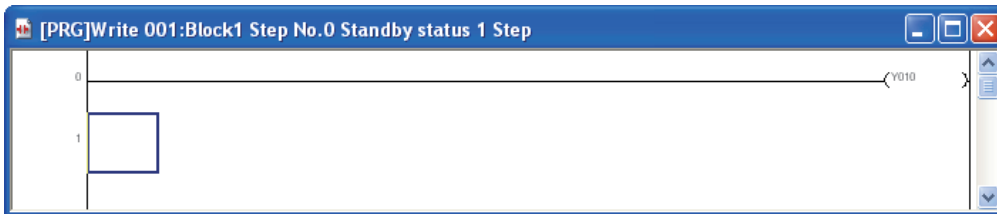

Point

● The step (□?) whose operation output is created will change into (□).

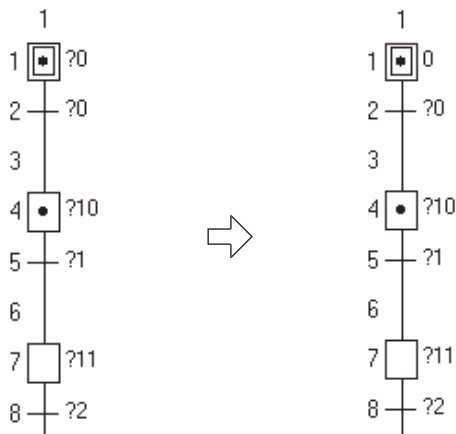

(To the next page)

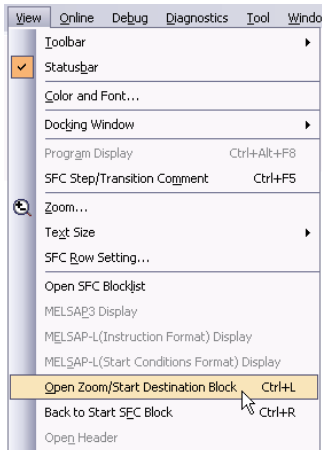

21. Creating the zoom (Transition condition of series transition 0)

Display the zoom.

For the display method, refer to the following.

☞ "Step20" in the 4.2.7

For operation output creation and ladder conversion, refer to the following.



☞ 3.2.6 Creating a program

☞ 3.2.7 Converting ladder blocks



Point

In the transition condition, the coil instruction accepts only one dummy coil ([TRAN]).

Click "  " or "  ", and click the button to enter the dummy coil. Then, "[TRAN]" will be entered automatically.

22. Creating the zoom (step10, series transition 1, step11, series transition 2, step12, series transition 3, step13, series transition 4, series transition 5)

For the zoom display and creation methods, refer to the following.

☞ "Step20" in the 4.2.7

☞ "Step21" in the 4.2.7

☞ "Point" in the Step21

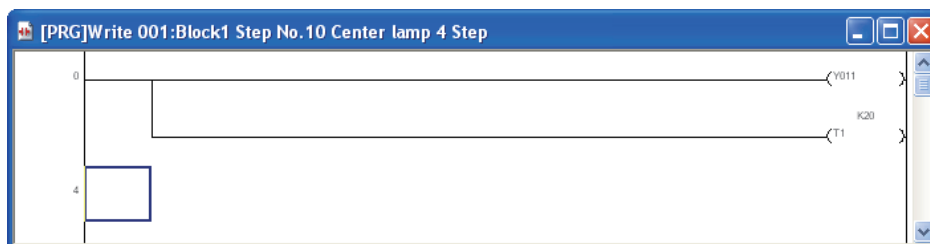

(To the next page)

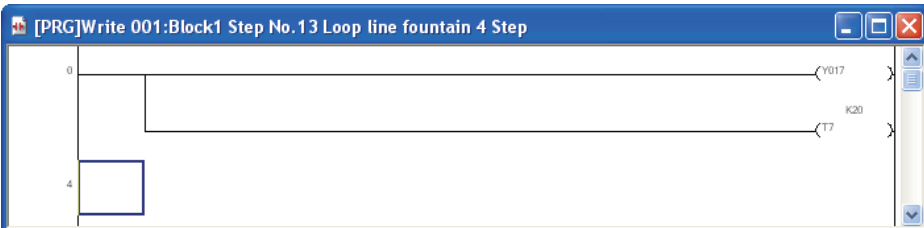
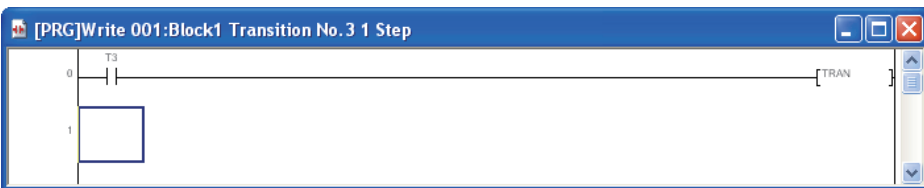
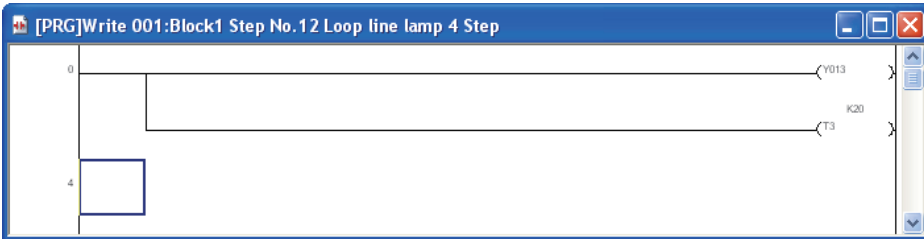
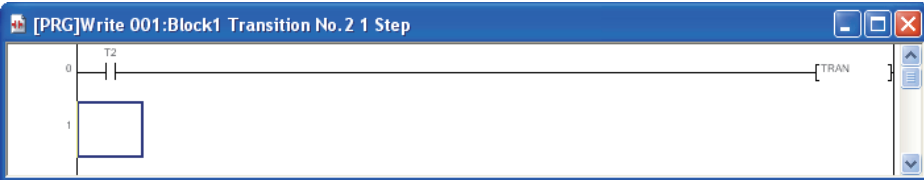
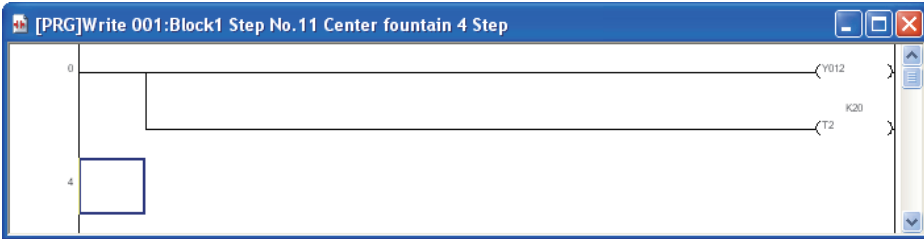
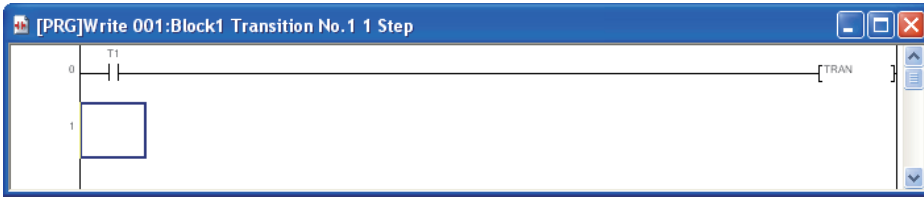

(To the next page)

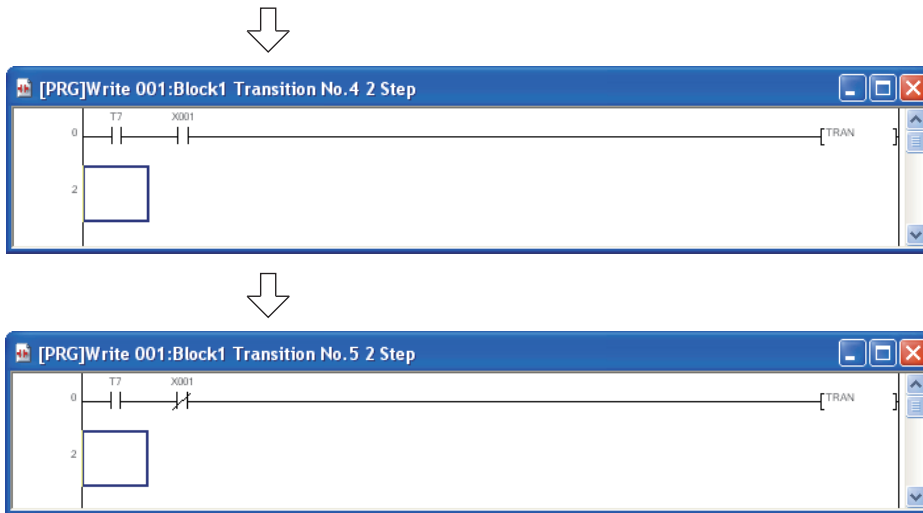

23. When the FXCPU is used, it is necessary to create a ladder for turning ON the SFC program using a ladder block. Double-click "000: Block Starting ladder", and create a necessary circuit.

In this example, the initial state S0 is set to ON using the special auxiliary relay M8002 that is actuated instantaneously when the programmable controller mode is changed from STOP to RUN.

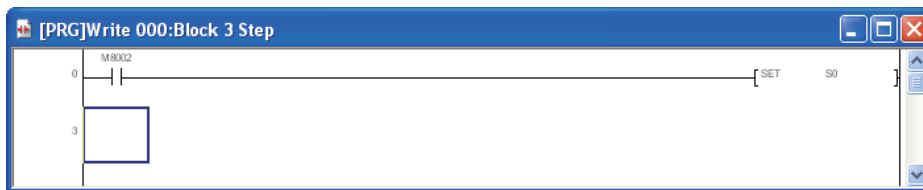
1
OVERVIEW2
CREATED PROGRAM
AND SYSTEM
CONFIGURATION3
CREATING A
PROGRAM OF
LADDER4
CREATING A
PROGRAM OF SFC

4.2.8 Compiling a program (for QCPU/LCPU) or converting an SFC diagram (for FXCPU)

■ Compiling a program (QCPU/LCPU)

For the program compiling procedure, refer to the following.

- ☞ 3.2.8 Compiling a program
- ☞ GX Works2 Version 1 Operating Manual (Simple Project)

■ Convert an SFC diagram (FXCPU)

Select [View] → [Back to Zoom SFC Block] to return to the SFC screen, and convert an SFC diagram.

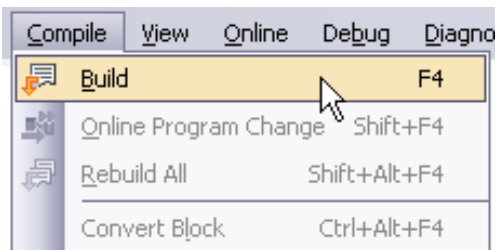

- Select [Compile] → [Build] to execute conversion.

4.3 Writing a Project to the programmable controller

For writing a project to the programmable controller CPU, refer to the following.

 3.3 Writing a Project to the programmable controller

4.4 Monitoring Operations

Execute "Monitor" to check the operations.

GX Works2 is able to simulate the programmable controller operation in offline mode.

Refer to the following manual for the simulation function.

 GX Works2 Version 1 Operating Manual (Common)

4.4.1 Monitoring a program

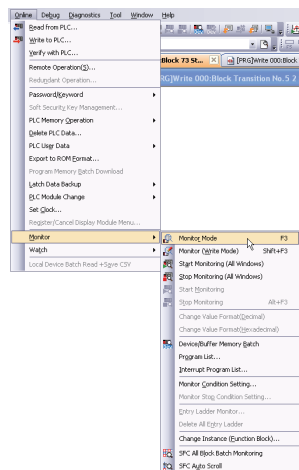
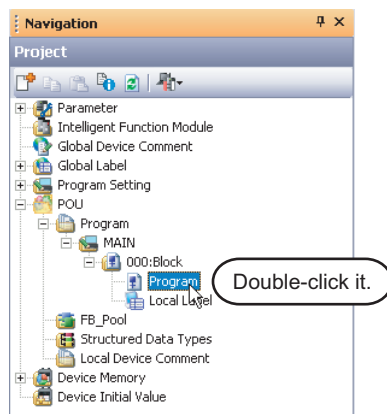
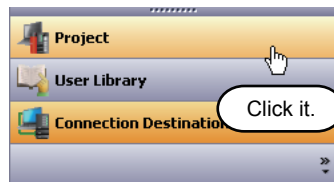

(To the next page)

1. Click "Project" in the view selection area on the Navigation window to display the Project view.

2. Double-click "POU" → "Program" → "MAIN" → "000: Block" → "Program" on the Project view screen to display the SFC screen for "[PRG] 000: Block".
When using the FX CPU, double-click "001: Block1 Fountain control".

3. Select [Online] → [Monitor] → [Monitor Mode] to switch the [PRG] 000: Block screen to the monitoring status.

You can also click  (Monitor Mode) to switch the [PRG] 000: Block screen to the monitoring status.

4. Set the programmable controller CPU to RUN.
Set the RUN/STOP switch on the programmable controller CPU to "RUN".

Point

You can switch the programmable controller status between "RUN" and "STOP" using remote operation as follows.

The Settings of the remote operation may vary depending on the programmable controller CPU used. Refer to the following manual for the details on remote operation:

☞ GX Works2 Version 1 Operating Manual (Common)

Select [Online] → [Remote Operation] to display the Remote Operation screen. You can switch the programmable controller status between "RUN" and "STOP" on this screen.

Connection Channel List information

Displays the connection target information currently set.

Programmable controller Status

Displays the programmable controller CPU status.

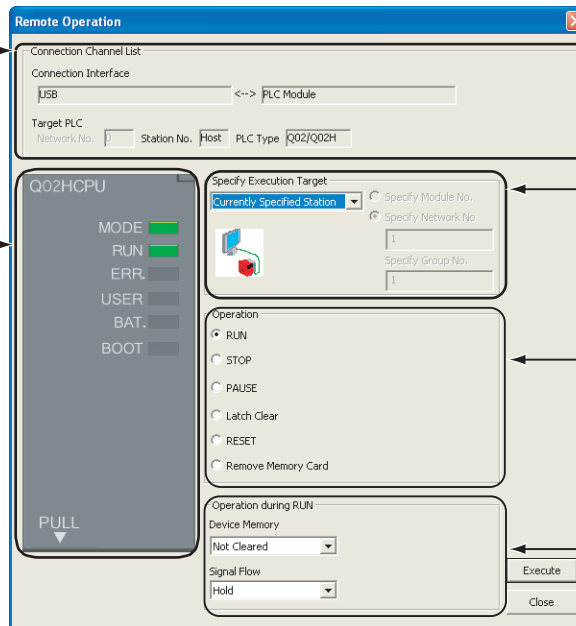

Specify Execution Target

Allows you to set the target station for remote operation. Select "Currently Specified Station" for this example.

Operation

Allows you to select the programmable controller CPU status to be set. Select either "RUN", "PAUSE" or "STOP" for this example.

Operation during RUN

Allows you to set the operations to be executed to the device memory and signal flow when the programmable controller CPU is switched to RUN.



(To the next page)

Monitor status display example

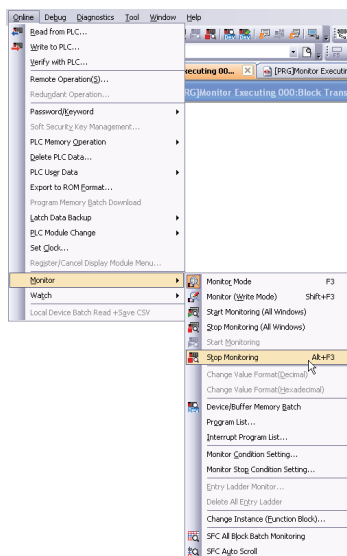
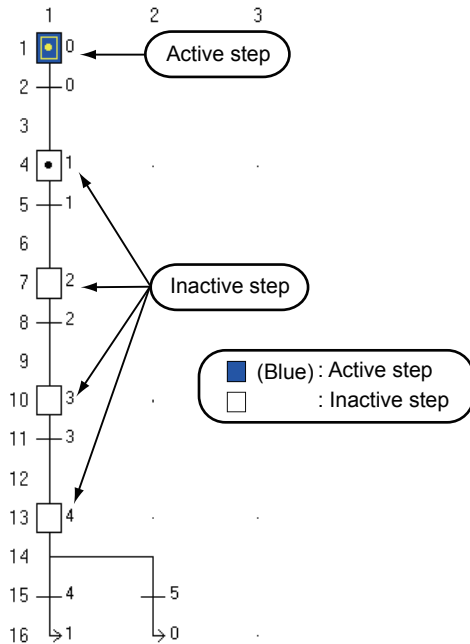

5. Select [Online] → [Monitor] → [Stop Monitoring] to reset the [PRG] 000: Block screen.

You can click  (Stop Monitoring) to reset the monitor status of the [PRG] MAIN screen.

6. Set the programmable controller CPU to STOP. Set the RUN/STOP switch on the programmable controller CPU to "STOP" using remote operation. You can switch the programmable controller CPU status "RUN" and "STOP" using remote operation. For the remote operation, refer to the following.

 "Point" in the step4

Switch the programmable controller CPU to the "Write" mode when editing the SFC programs. Refer to the following manual for details of the "Overwrite" mode, "Insert" mode, "Write" mode and "Read" mode.

 3.2.6 Creating a program

4.4.2 Batch monitoring of device values

For the Batch monitoring of device values procedure, refer to the following.

 3.4.2 Batch monitoring of device values

1 OVERVIEW

2 CREATED PROGRAM AND SYSTEM CONFIGURATION

3 CREATING A PROGRAM OF LADDER

4 CREATING A PROGRAM OF SFC

4.5 Diagnosing the programmable controller

You can check the programmable controller RUN/STOP status and error status.
Refer to the following section for the diagnosis procedure:

 3.5 Diagnosing the programmable controller

4.6 Reading a Project from programmable controller

Refer to the following section for the procedure to read a project from the programmable controller:

 3.6 Reading a Project from programmable controller

4.7 Printing

For the Printing a project procedure, refer to the following.

 3.7 Printing

There are following differences in the case of SFC programs.

- Previewing a program: The Print Window Preview (Ladder) screen is not displayed.
- Printing a program : The Print Window screen is displayed.

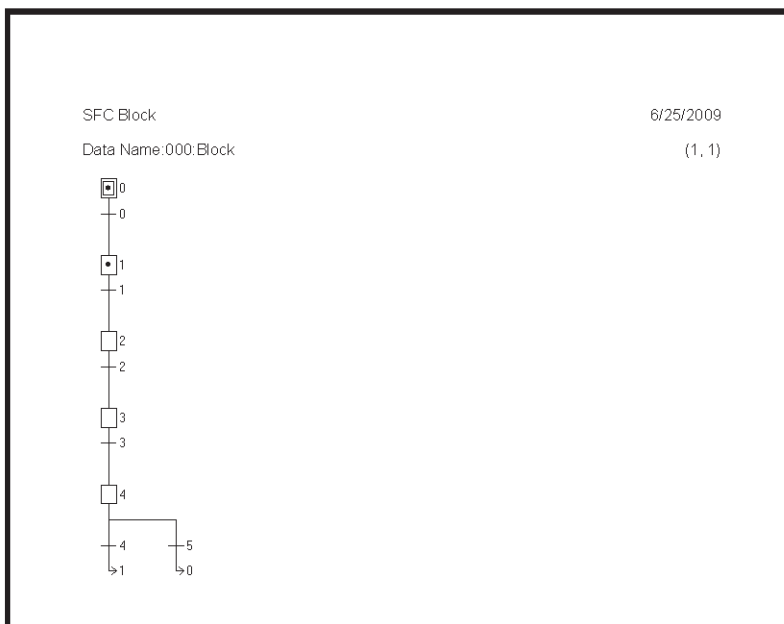

4.8 Saving a Project

For the Saving a Project procedure, refer to the following.

 3.8 Saving a Project

4.9 Exiting GX Works2

Refer to the following section for the project ending procedure:

 3.9 Exiting GX Works2

Microsoft, Windows are registered trademarks of Microsoft Corporation in the United States and other countries.

Ethernet is a registered trademark of Xerox Corp.

Other company names and product names used in this document are trademarks or registered trademarks of respective companies.

SH(NA)-080787ENG-P(1506)KWIX

MODEL: GXW2-HOW-O-SP-E

MODEL CODE: 13JZ22

MITSUBISHI ELECTRIC CORPORATION

HEAD OFFICE : TOKYO BUILDING, 2-7-3 MARUNOUCHI, CHIYODA-KU, TOKYO 100-8310, JAPAN
NAGOYA WORKS : 1-14, YADA-MINAMI 5-CHOME, HIGASHI-KU, NAGOYA, JAPAN

When exported from Japan, this manual does not require application to the
Ministry of Economy, Trade and Industry for service transaction permission.

Specifications subject to change without notice.